

ROCK

DESIGNED FOR
enduring impressions

COLOR BODY

Leading with Integrity and Innovation!

With more than 10+ years of experience in the industry, we are a leading-edge ceramic products manufacturing company with a vision to develop and deliver outstanding surface solutions for our clients. The upward graph of the Rock Granito is the outcome of its efforts to stay ahead of time.

Our manufacturing and processing units are equipped with state-of-the-art technology, efficient processes, expert workforces, and high-tech machinery, all synergizing towards our mission to produce quality products at a competitive price while fostering a climate where environmental technologies can thrive.

At Rock Granito, we recognize that when we listen to others, we cultivate the curiosity and empathy to unlock innovation. Our people are the driving force of the business. We endeavor to leverage talent and innovation to realize our global aspirations and harness the opportunity for the young and growing India.

index

LARGE PORCELAIN SURFACES

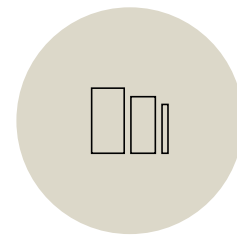

A COMPLETE SYSTEM OF
EXTRA LARGE SLABS.



INSPIRATION AND
SURFACES.



RANGE



APPLICATIONS AND
ADVANTAGES

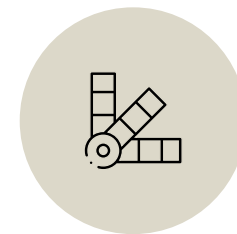

PRODOUCT

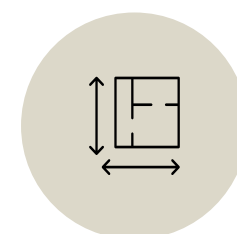

TECHNICAL INFORMATION

MONUMENTAL FORMAT MINIMAL THICKNESS

*3 format size,
6 color body*



Specific answers to any need.
3 sizes, 15 thickness
and 6 color body.

Designed to elevate large
architectural spaces, our
80x300 cm, 80x320 and
80x240 cm porcelain slabs
redefine surface continuity.

With an elegant 15 mm
thickness, these slabs offer a
perfect balance of strength,
lightness, and refined
aesthetics ideal for modern
interiors.



MADE FOR *contemporary living*

FROM RESIDENTIAL INTERIORS TO HIGH-TRAFFIC COMMERCIAL ENVIRONMENTS, LARGE SLABS OFFER A PERFECT BALANCE OF ELEGANCE, DURABILITY, AND EASE OF MAINTENANCE. LONG LIFESPAN, EFFICIENT MATERIAL USE, AND LOW MAINTENANCE CONTRIBUTE TO ENVIRONMENTALLY CONSCIOUS DESIGN AND SUSTAINABLE CONSTRUCTION.



INSPIRATION AND SURFACES.

This slabs are the outcome of careful research on style and of refined choices in terms of design. This blend has led to the creation of a range, which includes marble, stone, concrete and metal effects, as well as plain colors. Caesar's solutions are completed by three surface finishes, which bring out the best of each look and are especially designed for the many intended uses of the slabs.

PRECISION AT EVERY LAYER

Advanced surface technology ensures uniform texture, consistent color, and superior finish quality across the entire slab, delivering reliable performance and refined aesthetics.

A STATEMENT OF SCALE.

Manufactured using advanced technology, each slab delivers consistent quality, structural integrity, and surface precision ensuring reliability across all applications. The large format minimizes joints and visual breaks, creating smooth, uninterrupted surfaces that enhance spatial flow and visual harmony.

A MATERIAL FOR MODERN PROJECTS

Future-Ready Design Solutions

Large slab surfaces answer the needs of evolving architecture combining innovation, efficiency, and refined design.

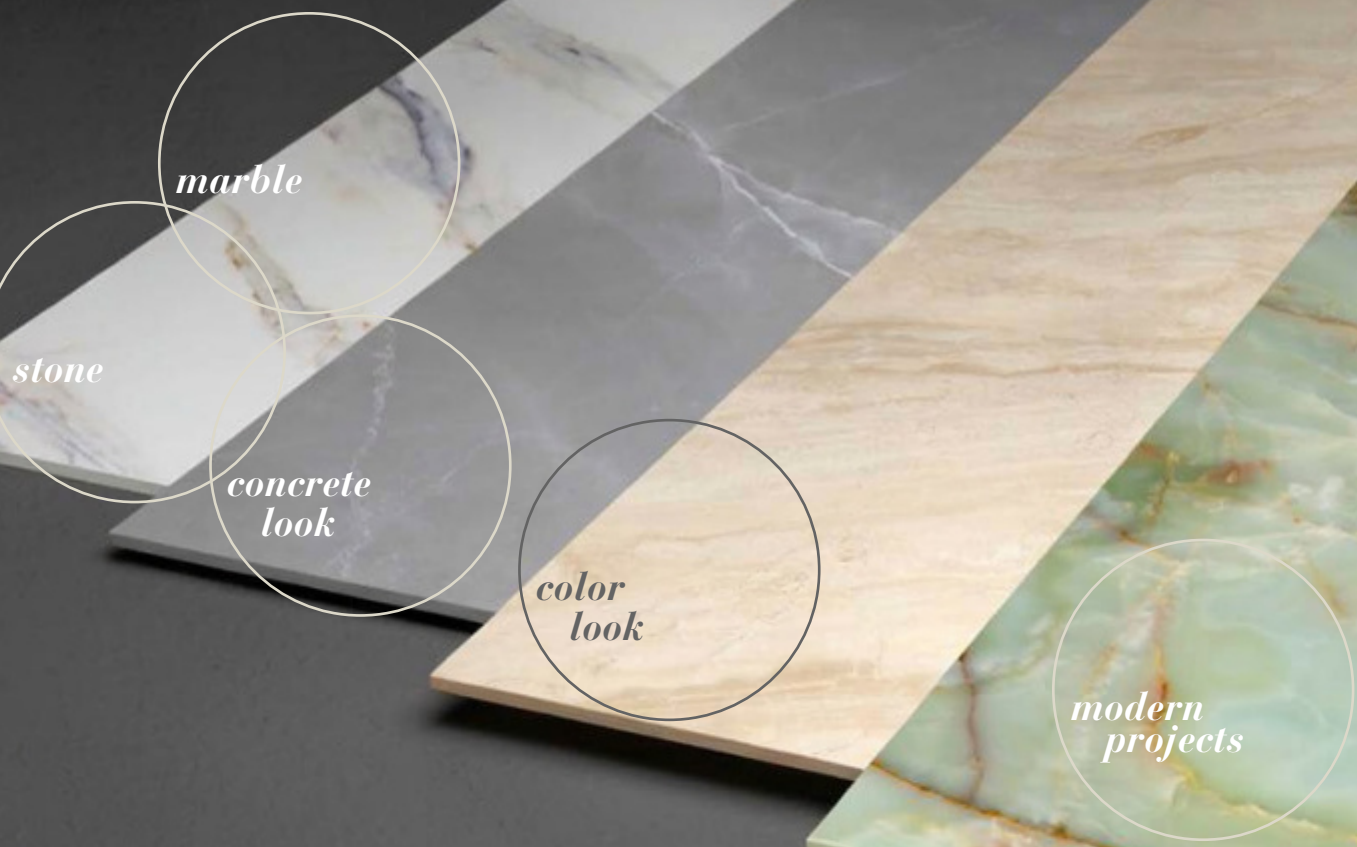

Product Range

Available Size

80X240 CM | 80X300 CM | 80X320 CM
15 MM THICKNESS

WHITE BODY

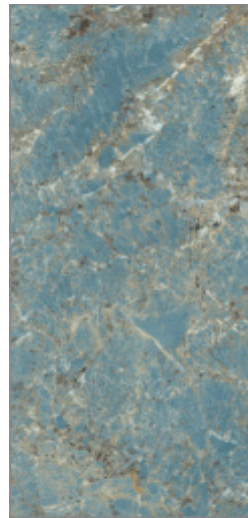

AMAZONITE



ARCTIC BIANCO

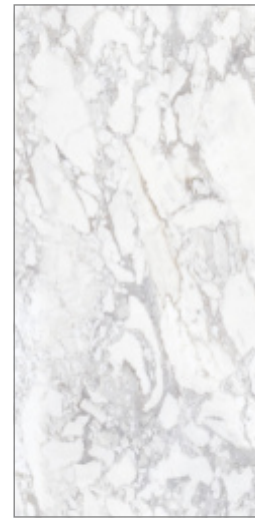

CALACATTA VAGLI



CALCITE AZUL

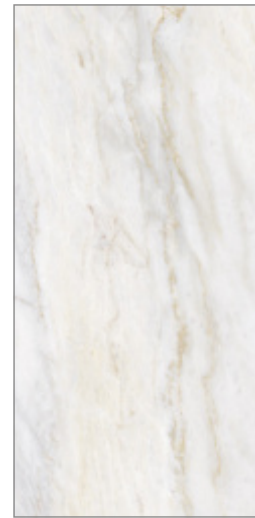

DELICATO WHITE

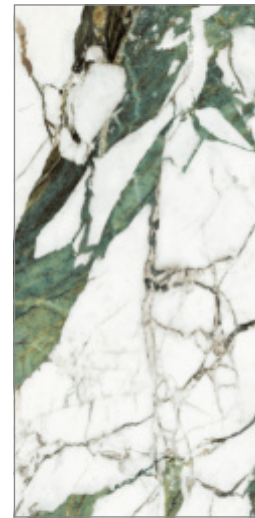

EXOTIC WHITE

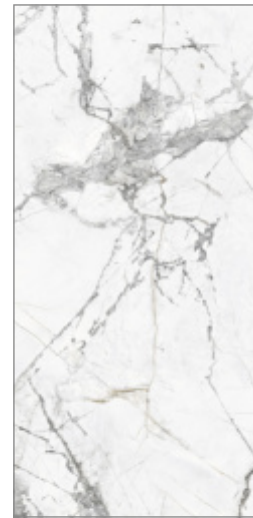

INVISIBLE NATURAL



LASA BIANCO

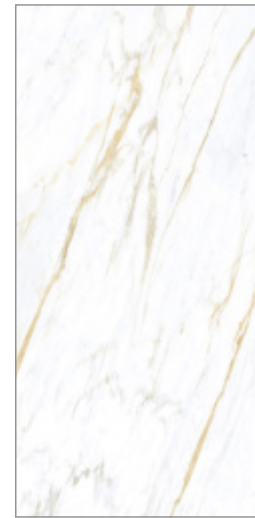

LUMINOUS GOLD

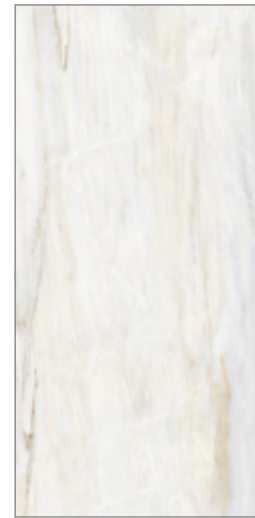

MICHEL ANGELO

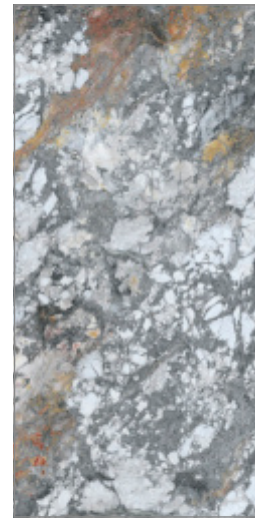

MYSTIC ROCK



ONYX GREY

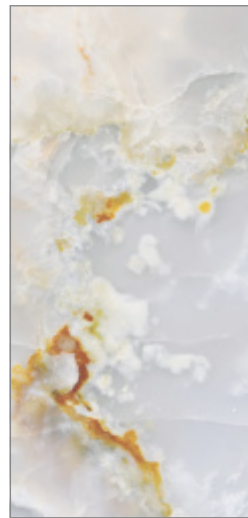

ONYX AMBRA

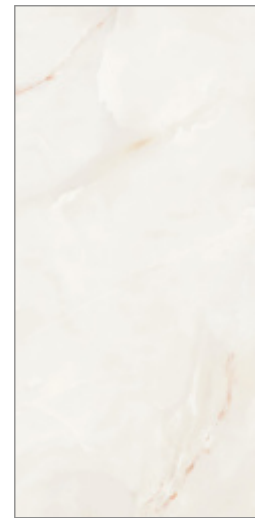

PEARL ONYX

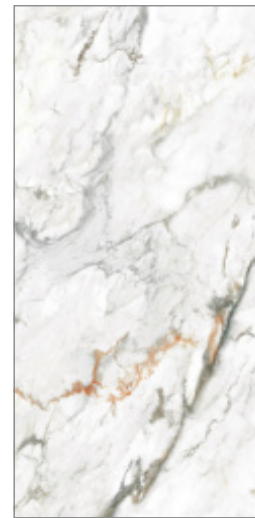

RADIANCE WHITE



REGAL STATUARIO

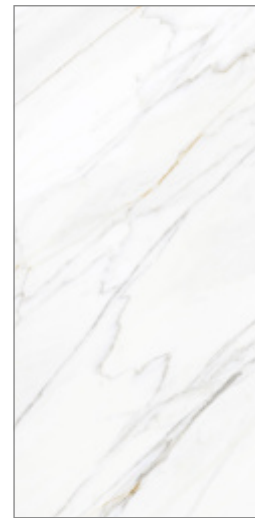

SERENA WHITE



STATUARIO ELEGANTE



STATUARIO EUROPA



STATUARIO ITALIA



STATUARIO VELA

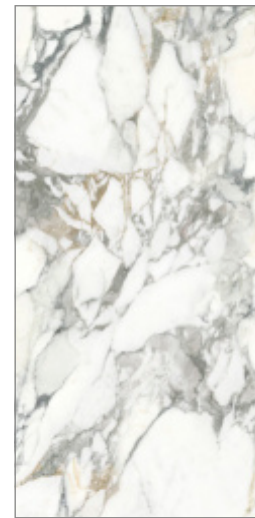

THUNDER WHITE

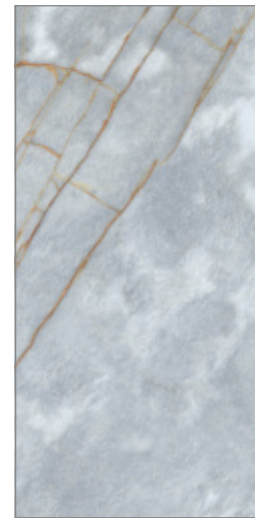

VENEZIA SKY

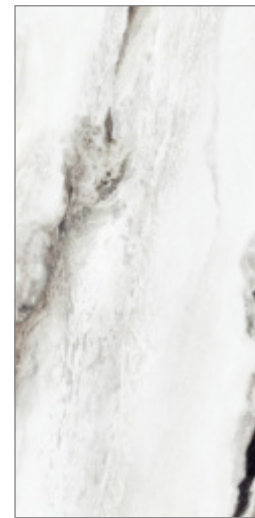

WHITE PANDA



Product Range

Available Size

80X240 CM | 80X300 CM | 80X320 CM
15 MM THICKNESS

IVORY BODY



AVORIO
CREMA

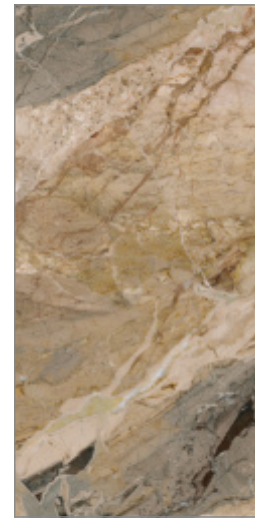

BLUE
BRECCIA

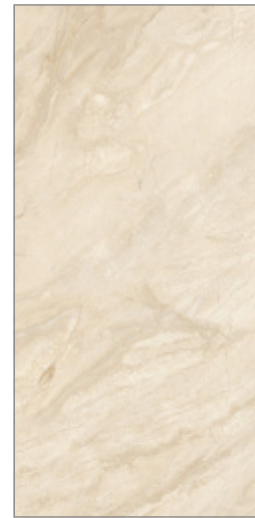

DYNA
ROYAL



EXOTIC
GOLD

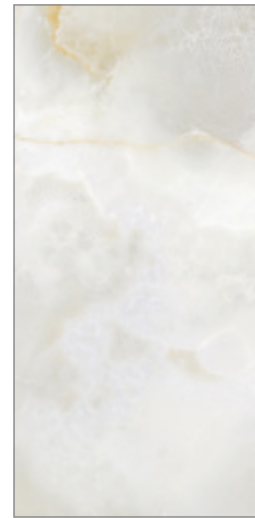

MARMO
ONYX

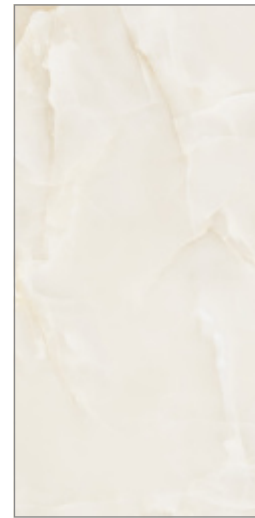

ONYX
GOLD

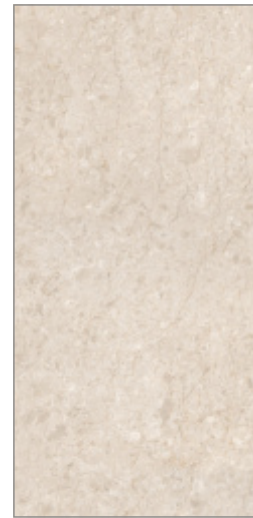

POLAR
BEIGE



ROMAN
TRAVERTINE



SUPREMO
BEIGE



TAJ
NUEVA

GREY BODY



ARMANI
GREY



CAPRON
GREY



LIMER
GREY

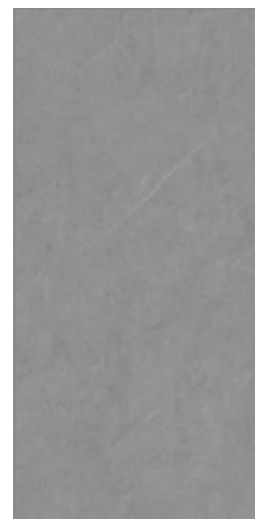

PIETRA
GREY



ROMAN
TRAVERTINE
SILVER



TIGER
ONYX



VERSACE
GOLD



Product Range

Available Size

80X240 CM | 80X300 CM | 80X320 CM
15 MM THICKNESS

BLACK BODY

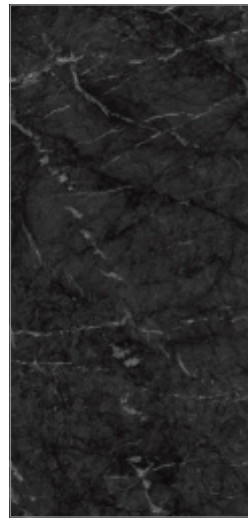

GRIGIO
INTENSO

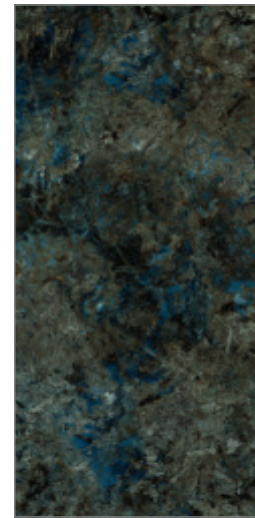

LABRADORITE

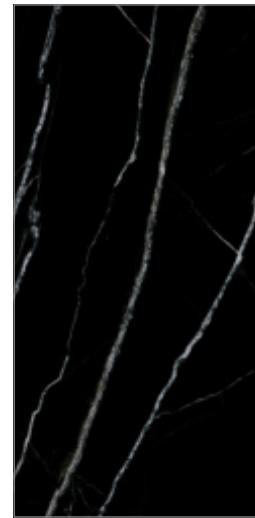

MARQUINA
NERO

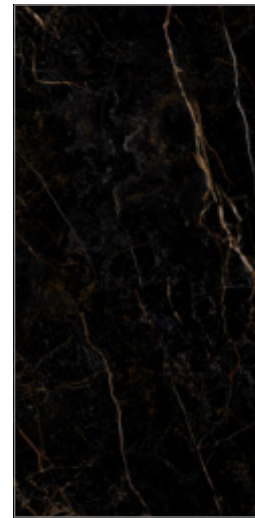

NOIR
BLACK

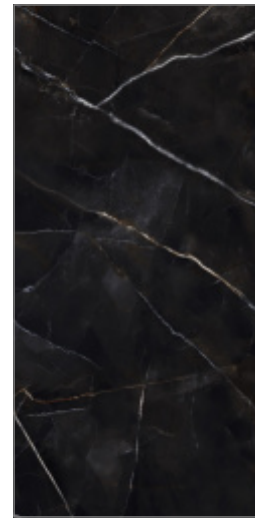

PRISMA
NOIR



SAINT
LAURENT

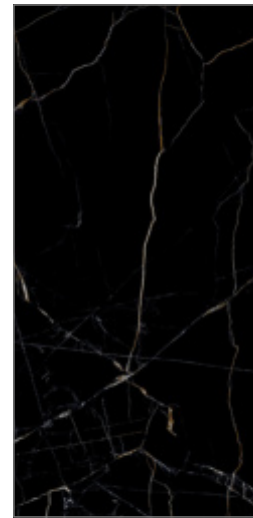

VEINS
BLACK

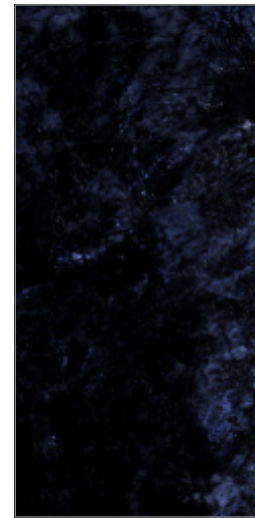

VOLGA
BLUE

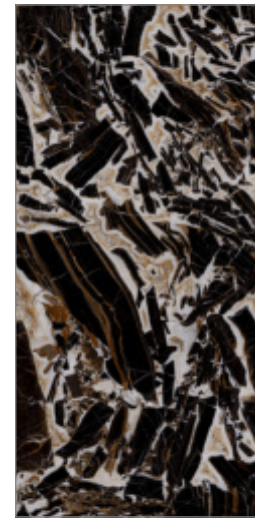

VORTEX
BROWN

BROWN BODY

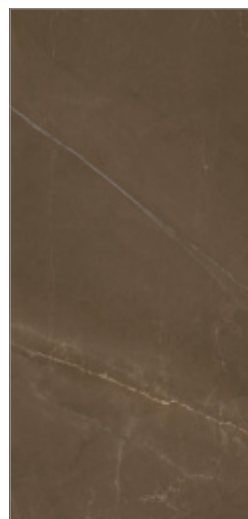

ARMANI
BROWN

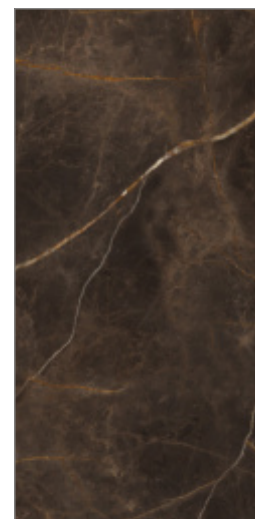

ELEGANT
BRONZE

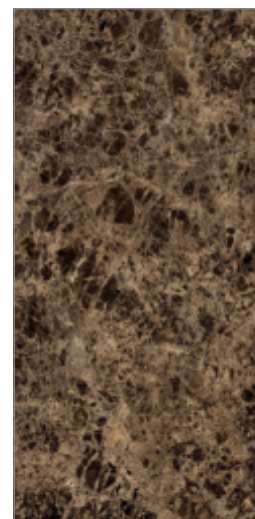

EMPERADOR
QUARTZ

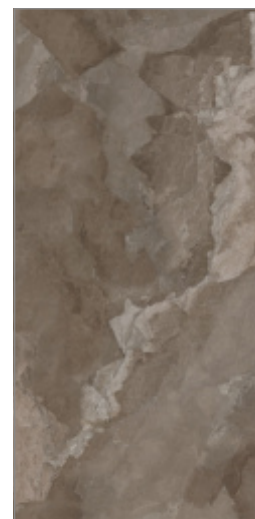

OLMPIYA

GREEN BODY



ONYX
GREEN



TAP ON
SLAB DISCOVER
YOUR MATCH

80x240cm
80x300cm
80x320cm

15mm

Applications

Large slab surfaces offer unmatched versatility, making them ideal for a wide range of architectural and interior applications.

Advantages

Large slab surfaces combine cutting-edge technology with refined aesthetics, delivering long-term value and design freedom.

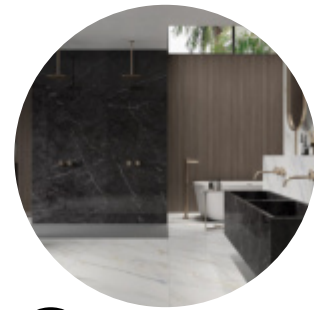

WALL

FULL WALL COVERAGE

Elevates interiors and façades with bold, uninterrupted design



DESIGN

Designed for Limitless Applications

Seamless Look Fewer joints create a clean, expansive visual flow

High Strength & Durability
Resistant to scratches, stains, heat, and wear

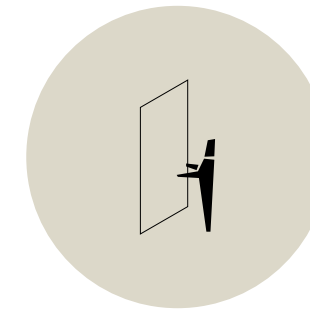
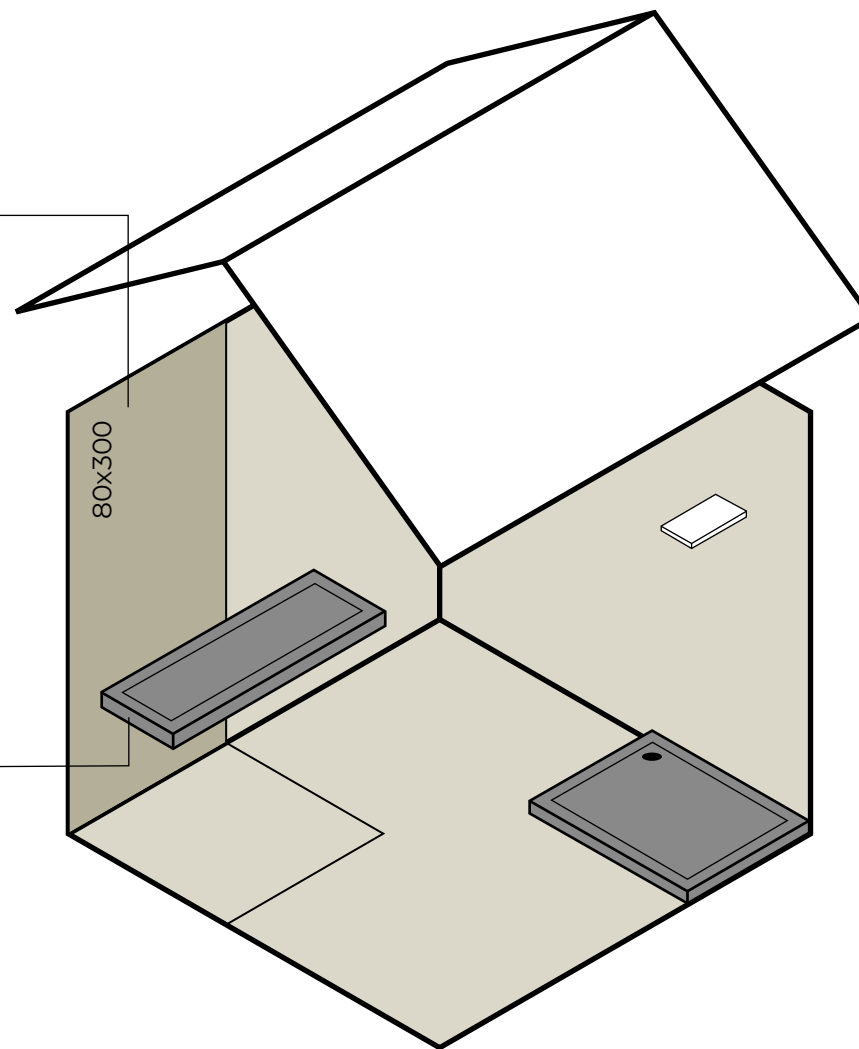

EASY TO HANDLE

Large slab surfaces are engineered for easy handling without compromising strength.

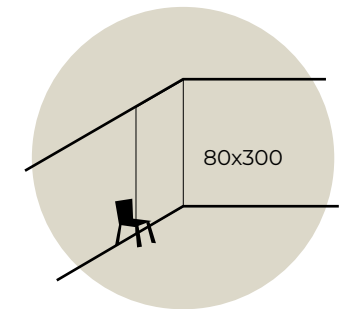

SUITABLE FOR FULL WALL COVERAGE

Perfectly suited for full wall coverage, large slabs deliver uninterrupted surfaces that elevate spaces.



EASY TO TRANSPORT

Despite their grand scale, large slab surfaces are crafted for effortless transportation.

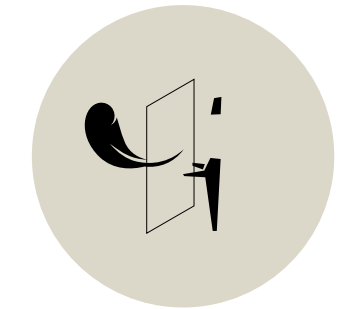

MANAGEABLE WEIGHT

Large slab surfaces in 15mm thickness offer an ideal balance of strength and manageable weight.

DESIGN + TECHNICAL

Engineered for precision cutting and shaping, large slab surfaces support customised furniture solutions while ensuring strength, stability, and long-lasting performance.

Perfect for bespoke furniture and large-scale contract applications, large slabs enable seamless designs with a refined, high-end finish.

80x240cm
80x300cm
80x320cm

15mm

Applications

Large slab surfaces offer unmatched versatility, making them ideal for a wide range of architectural and interior applications.

Advantages

Large slab surfaces combine cutting-edge technology with refined aesthetics, delivering long-term value and design freedom.

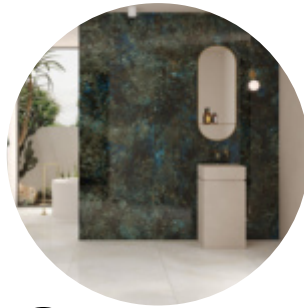

WALL

WALLS OF LARGE INTERIOR SPACES

Large slab surfaces create striking wall designs with seamless continuity and refined elegance. The expansive format minimizes joints, enhancing visual flow and delivering a bold architectural presence.



CLADDING

EXTERIOR WALLS

Ideal for exterior wall applications, large slab surfaces offer durability, weather resistance, and long-lasting visual appeal.



DESIGN

FURNITURE AND INTERIOR DESIGN

Perfect for furniture and interior design applications, these slabs enhance spaces with refined surfaces and contemporary elegance.

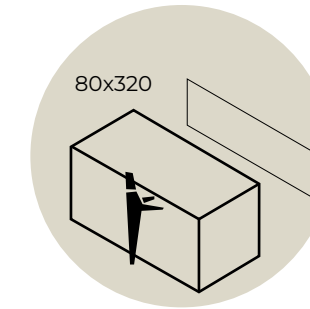
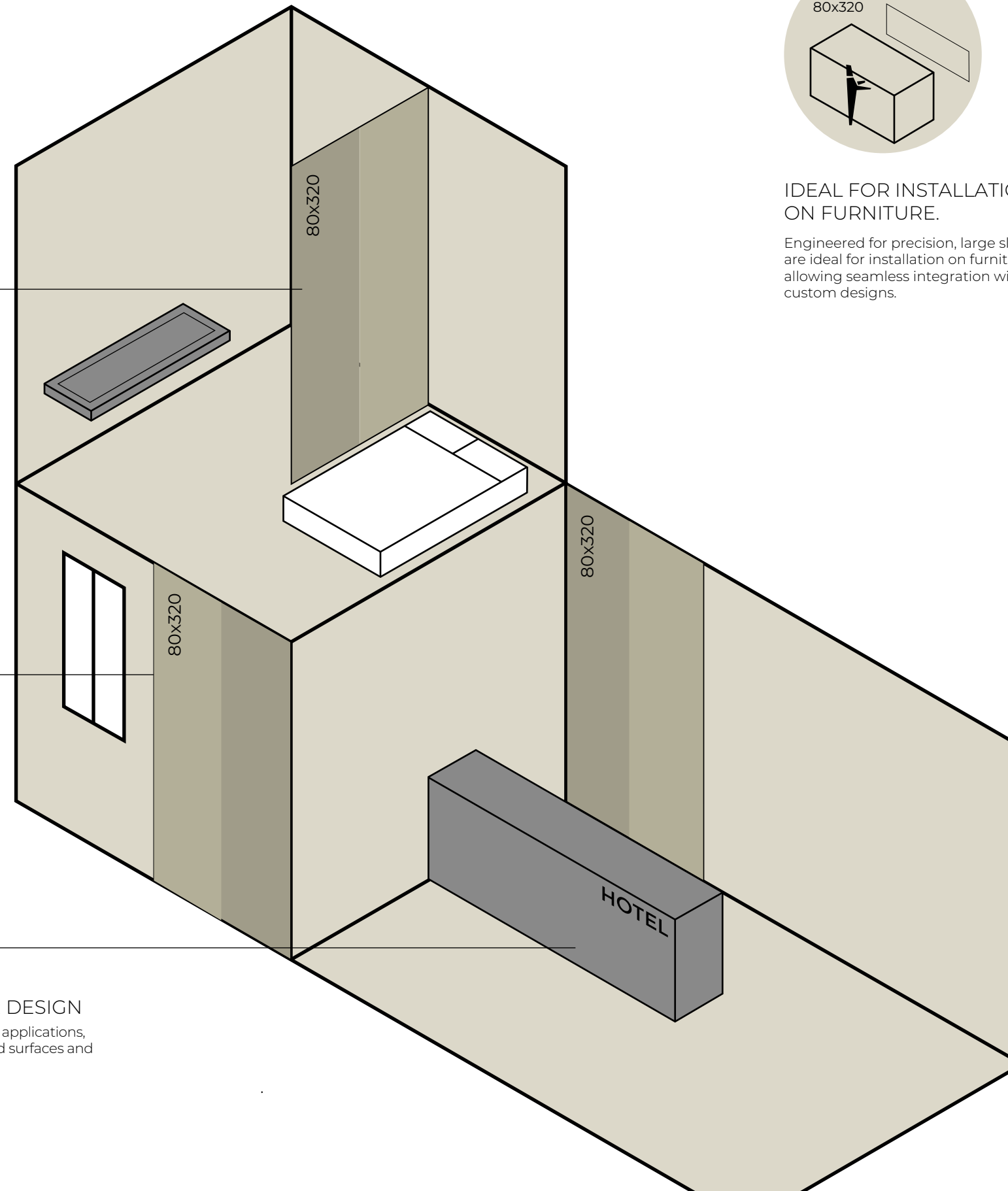

IDEAL FOR INSTALLATION ON FURNITURE.

Engineered for precision, large slabs are ideal for installation on furniture, allowing seamless integration with custom designs.

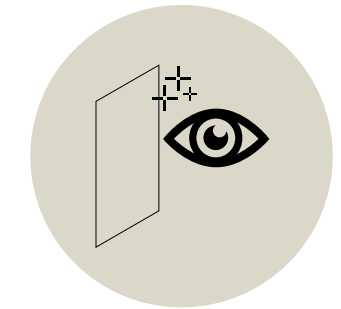

TOP LEVEL AESTHETICS

Exceptional surface detailing and finishes deliver top-level aesthetics that elevate both modern and classic environments.

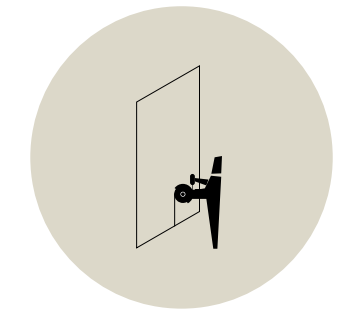

EASY TO PROCESS (holes, cuts, etc.).

Designed for easy processing, slabs allow precise cutting, drilling, and shaping without compromising surface quality.

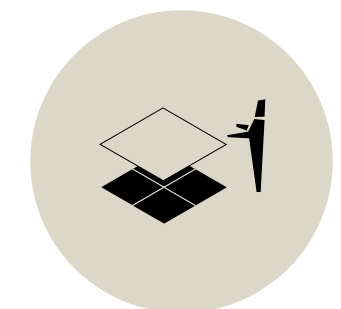

RECOMMENDED FOR FLOOR RENOVATION

Lightweight yet strong, these slabs are recommended for renovating existing floors, enabling installation without extensive structural changes.

MINIMAL JOINTS AND EXPANSIVE FORMATS ALLOW THE NATURAL FLOW OF DESIGN TO TAKE CENTER STAGE.

REDEFINING SURFACES.
EXPANDING POSSIBILITIES.

PRODUCED WITH RESPONSIBLE PRACTICES AND LONG-LASTING MATERIALS, LARGE SLAB SURFACES CONTRIBUTE TO SUSTAINABLE

CONSTRUCTION BY REDUCING WASTE, INCREASING LONGEVITY



Seamless Look Fewer joints create a clean, expansive visual flow.

Precision & Consistency Uniform thickness and accurate edges ensure flawless installation

Designed to adapt across applications, large slab surfaces provide design continuity for walls, floors, furniture, and architectural elements.

Minimal joints enhance surface flow, creating clean lines and a spacious, uninterrupted appearance.

Designed for full wall coverage, large slabs offer smooth continuity and a refined, joint-free appearance.

With expansive dimensions and precision edges, large slab surfaces enable flawless full wall coverage while reducing visible joints and installation lines.

Durability for Daily Use Resistant to wear, stains, and moisture, large slabs maintain their appearance even in high-use environments.

Large dimensions allow creative layouts, custom cuts, and bold surface expressions without visual breaks.

bathroom

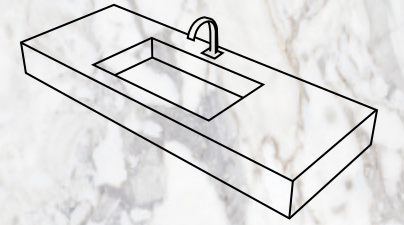

kitchen

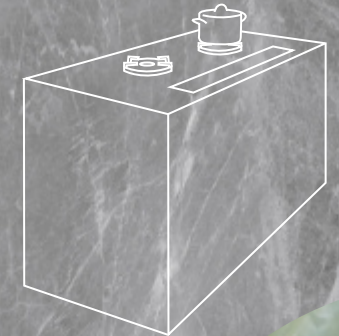

living



contract

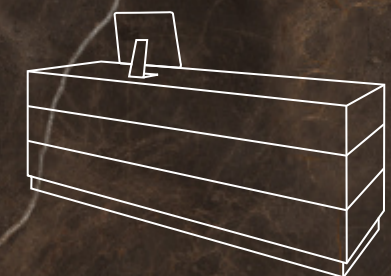

SUGGESTIONS FOR APPLICATION

bathroom

LARGE SLAB SURFACES ARE IDEAL FOR BATHROOM SPACES, OFFERING SEAMLESS WALL AND FLOOR COVERAGE WITH

MINIMAL JOINTS. THEIR NON-POROUS, MOISTURE-RESISTANT SURFACE ENSURES HYGIENE, EASY MAINTENANCE, AND LASTING ELEGANCE IN WET ENVIRONMENTS.

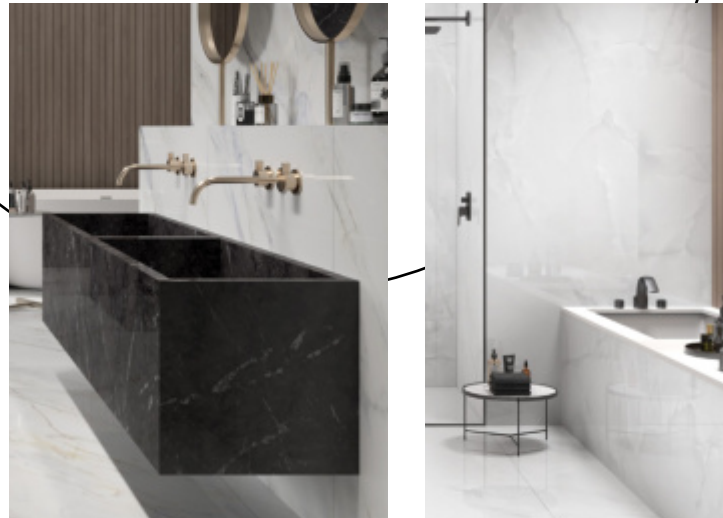

kitchen

Large slab surfaces are ideal for kitchens, offering seamless countertops and wall cladding with minimal joints. Their non-porous, hygienic surface ensures easy cleaning while maintaining a refined, modern aesthetic.

Designed for contemporary kitchens, large slabs create bold

Work tops, kitchen sinks, tables, shelves.



living

Large slab surfaces enhance living spaces with seamless wall and floor coverage, creating a spacious and elegant environment with minimal joints and refined textures.

Table tops and coffee tables for interiors and exteriors, benches, shelves, partitions.



contract

Customised furniture for hotels and shops, such as modules for bathrooms, reception desks, shelves, benches, tables.

Perfect for bespoke furniture and large-scale contract applications, large slabs enable seamless designs with a refined, high-end finish.





 **WHITE
BODY**



| AMAZONITE

● WHITE BODY

| HIGH GLOSSY

| 80X240 CM / 80X300 CM / 80X320 CM

WHITE
BODY

ROCK

A pure white body paired with a glossy finish
creates a surface that reflects light with flawless clarity.

Designed to express modern elegance.

| AMAZONITE

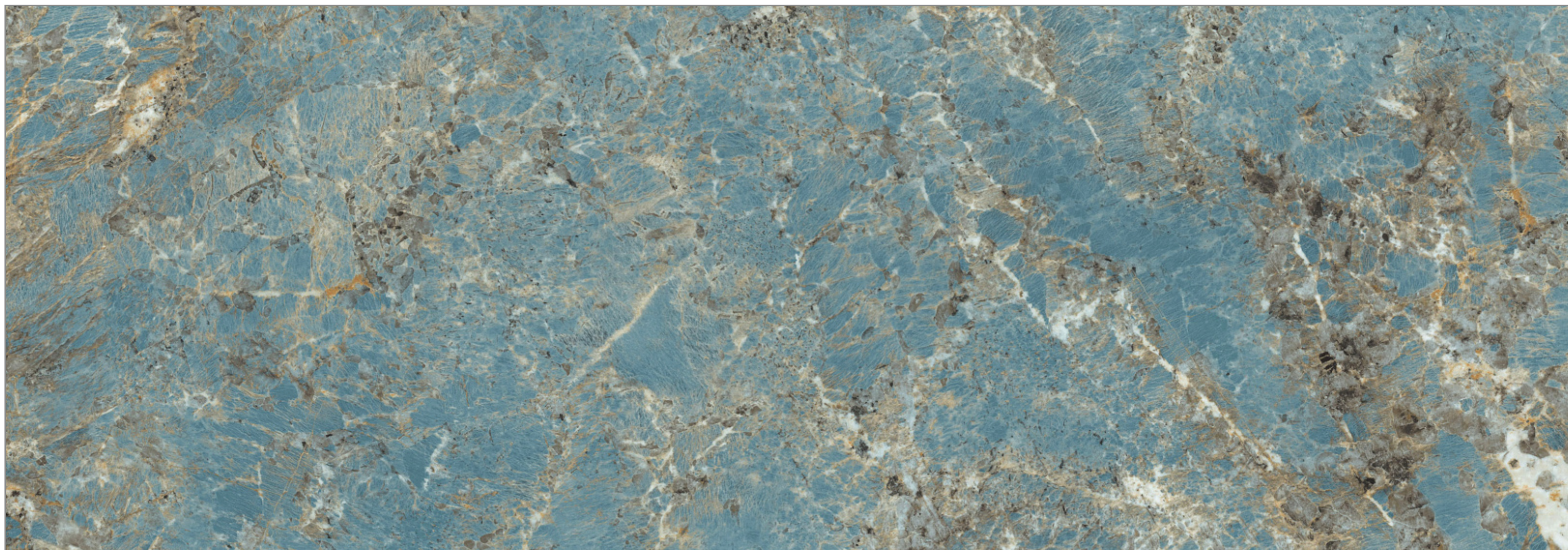

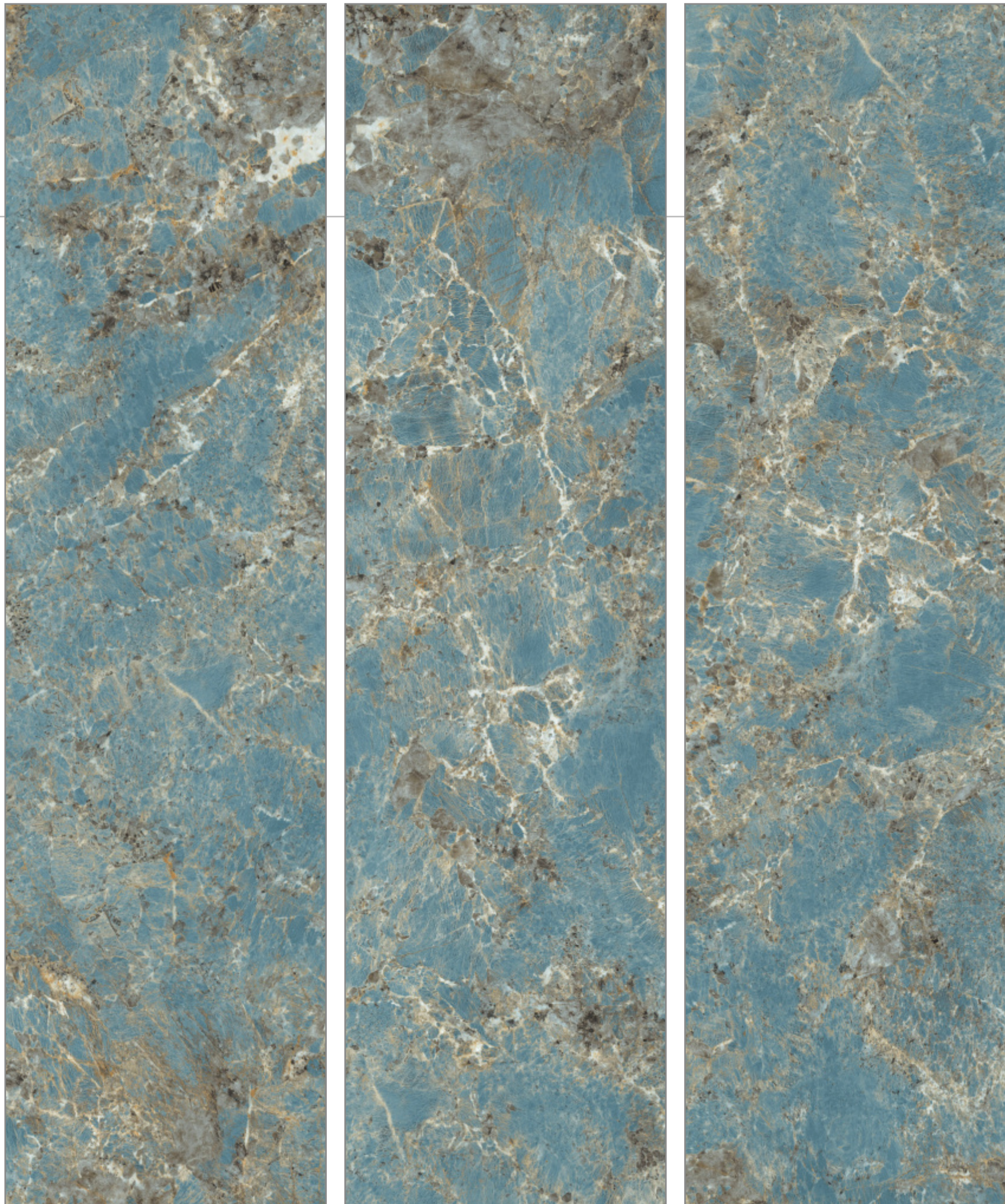

WHITE
BODY

ROCK

| AMAZONITE

FINISH • HIGH GLOSSY
THICKNESS • 15 MM
RANDOM • 3
AVAILABLE SIZES •

80X
240 CM

80X
300 CM

80X
320 CM

 BACK TO
INDEX





| ARCTIC BIANCO

● WHITE BODY

| GLOSSY

| 80X240 CM / 80X300 CM / 80X320 CM

A bright white surface with a
polished finish captures light in every curve.

Reflecting clarity, elegance, and understated luxury.

| ARCTIC BIANCO

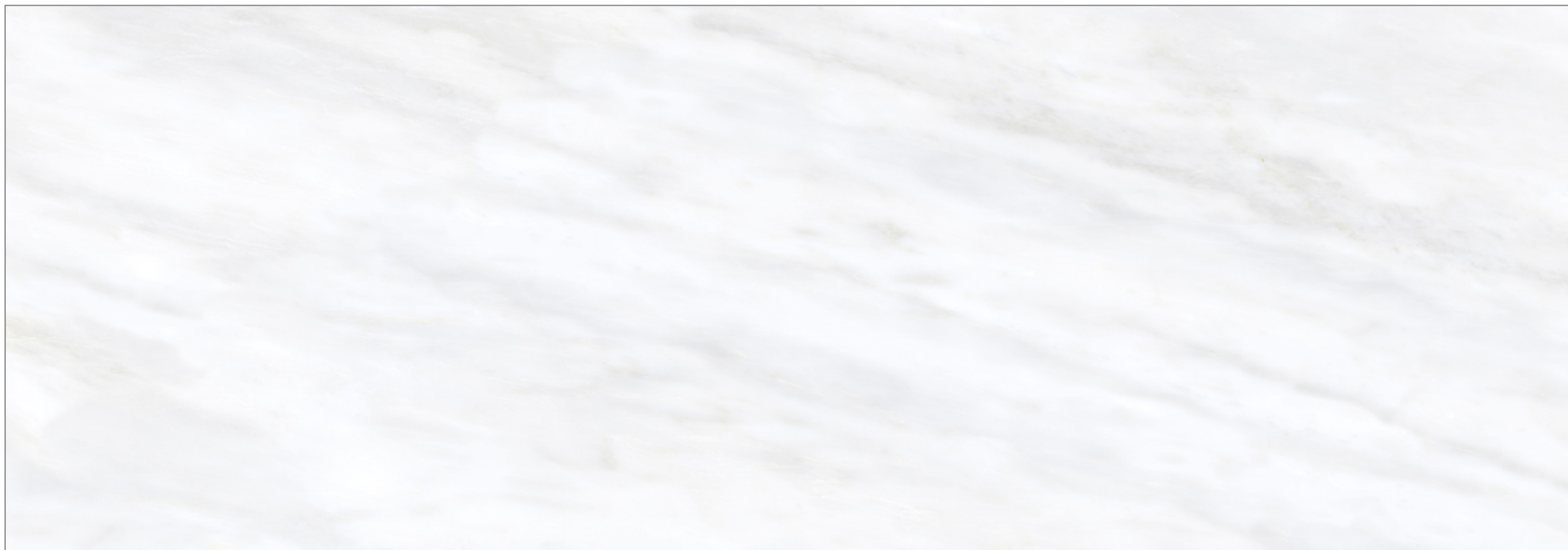



 **WHITE
BODY**

ROCK

| **ARCTIC BIANCO**

FINISH • GLOSSY
THICKNESS • 15 MM
RANDOM • 3
AVAILABLE SIZES •

80X
240 CM

80X
300 CM

80X
320 CM

 **BACK TO
INDEX**





| CALACATTA VAGLI

● WHITE BODY

| GLOSSY

| 80X240 CM / 80X300 CM / 80X320 CM

Crisp white tones enhanced by a polished gloss
create a surface that feels luminous and refined.

Made for timeless appeal.

| CALACATTA VAGLI





WHITE
BODY

ROCK

| CALACATTA VAGLI

FINISH • GLOSSY
THICKNESS • 15 MM
RANDOM • 3
AVAILABLE SIZES •

80X
240 CM

80X
300 CM

80X
320 CM

 BACK TO
INDEX





| CALCITE AZUL

● WHITE BODY

| GLOSSY

| 80X240 CM / 80X300 CM / 80X320 CM

A smooth white base finished with gentle shine
creates a surface that feels bright and sophisticated.

Crafted for effortless beauty.

| CALCITE AZUL





**WHITE
BODY**

ROCK

| CALCITE AZUL

FINISH • GLOSSY
THICKNESS • 15 MM
RANDOM • 3
AVAILABLE SIZES •

80X
240 CM

80X
300 CM

80X
320 CM

 **BACK TO
INDEX**





| DELICATO WHITE

● WHITE BODY

| GLOSSY

| 80X240 CM / 80X300 CM / 80X320 CM

A sleek white base polished to perfection
creates a surface that radiates refinement.

Designed to leave a lasting impression of clarity and purity.

| DELICATO WHITE





 **WHITE
BODY**

ROCK

| **DELICATO WHITE**

FINISH • GLOSSY
THICKNESS • 15 MM
RANDOM • 2
AVAILABLE SIZES •

80X
240 CM

80X
300 CM

80X
320 CM

 **BACK TO
INDEX**





| EXOTIC WHITE

● WHITE BODY

| HIGH GLOSSY

| 80X240 CM / 80X300 CM / 80X320 CM

White surfaces with a reflective
gloss capture attention without excess.

Balancing minimalism with premium presence.

| EXOTIC WHITE





WHITE
BODY

ROCK

| EXOTIC WHITE

FINISH • HIGH GLOSSY
THICKNESS • 15 MM
RANDOM • 3
AVAILABLE SIZES •

80X
240 CM

80X
300 CM

80X
320 CM

 BACK TO
INDEX





| INVISIBLE NATURAL

● WHITE BODY

| GLOSSY

| 80X240 CM / 80X300 CM / 80X320 CM

White surfaces with a reflective
gloss capture attention without excess.

Balancing minimalism with premium presence.

| INVISIBLE NATURAL

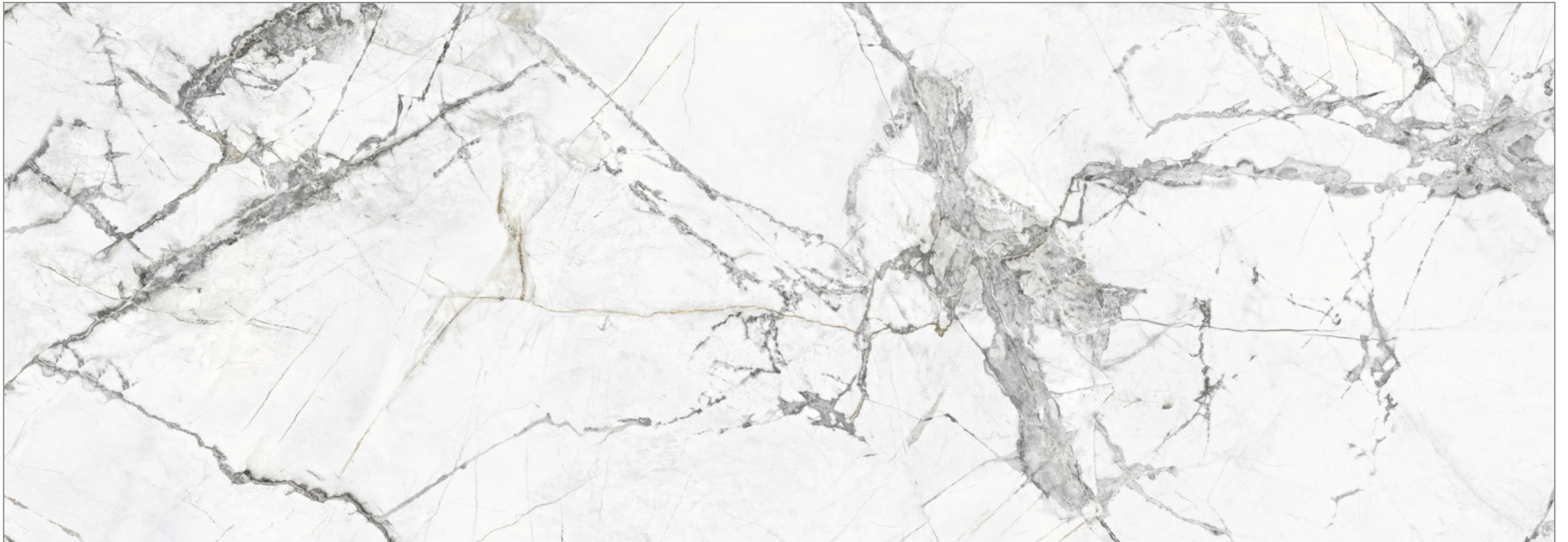



WHITE
BODY

ROCK

| INVISIBLE NATURAL

FINISH • GLOSSY
THICKNESS • 15 MM
RANDOM • 3
AVAILABLE SIZES •

80X
240 CM

80X
300 CM

80X
320 CM

 BACK TO
INDEX





| LASA BIANCO

● WHITE BODY

| GLOSSY

| 80X240 CM / 80X300 CM / 80X320 CM

A refined white foundation elevated through glossy
brilliance creates a surface that feels airy and premium.

Designed for pure luxury.

| LASA BIANCO

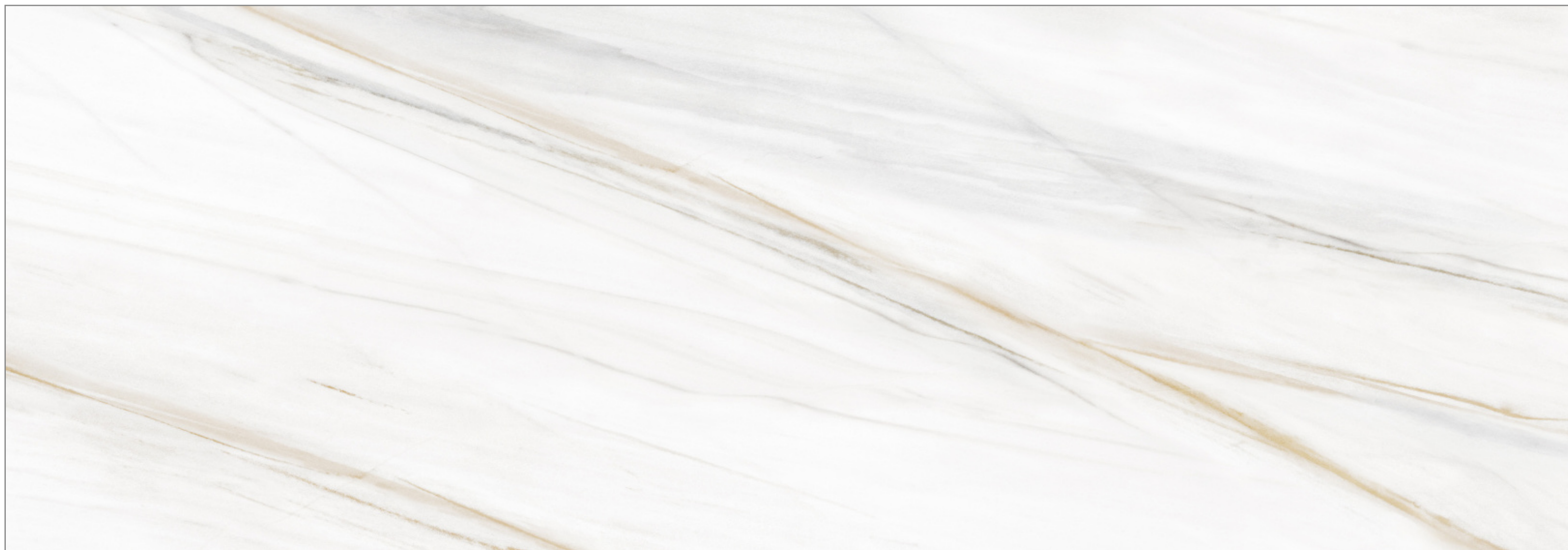



 **WHITE
BODY**

ROCK

| **LASA BIANCO**

FINISH • GLOSSY
THICKNESS • 15 MM
RANDOM • 3
AVAILABLE SIZES •

80X
240 CM

80X
300 CM

80X
320 CM

 **BACK TO
INDEX**





| LUMINOUS GOLD

● WHITE BODY

| GLOSSY

| 80X240 CM / 80X300 CM / 80X320 CM

White-inspired tones finished with a subtle sheen
create a surface that feels radiant and classic.

Made to shine with elegance.

| LUMINOUS GOLD





**WHITE
BODY**

ROCK

| LUMINOUS GOLD

FINISH • GLOSSY
THICKNESS • 15 MM
RANDOM • 3
AVAILABLE SIZES •

80X
240 CM

80X
300 CM

80X
320 CM

 **BACK TO
INDEX**





| MICHEL ANGELO

● WHITE BODY

| GLOSSY

| 80X240 CM / 80X300 CM / 80X320 CM

Bright white tones accented with subtle veining
create a surface that feels luminous and elegant.

Designed for spaces that reflect purity and sophistication.

| MICHEL ANGELO





**WHITE
BODY**

ROCK

| MICHEL ANGELO

FINISH • GLOSSY
THICKNESS • 15 MM
RANDOM • 3
AVAILABLE SIZES •

80X
240 CM

80X
300 CM

80X
320 CM

 **BACK TO
INDEX**





| MYSTIC ROCK

● WHITE BODY

| HIGH GLOSSY

| 80X240 CM / 80X300 CM / 80X320 CM

Gentle stone-grey shades meet restrained textures
creating surfaces that are both calm and composed.

Made for environments that value lasting quality.

| MYSTIC ROCK

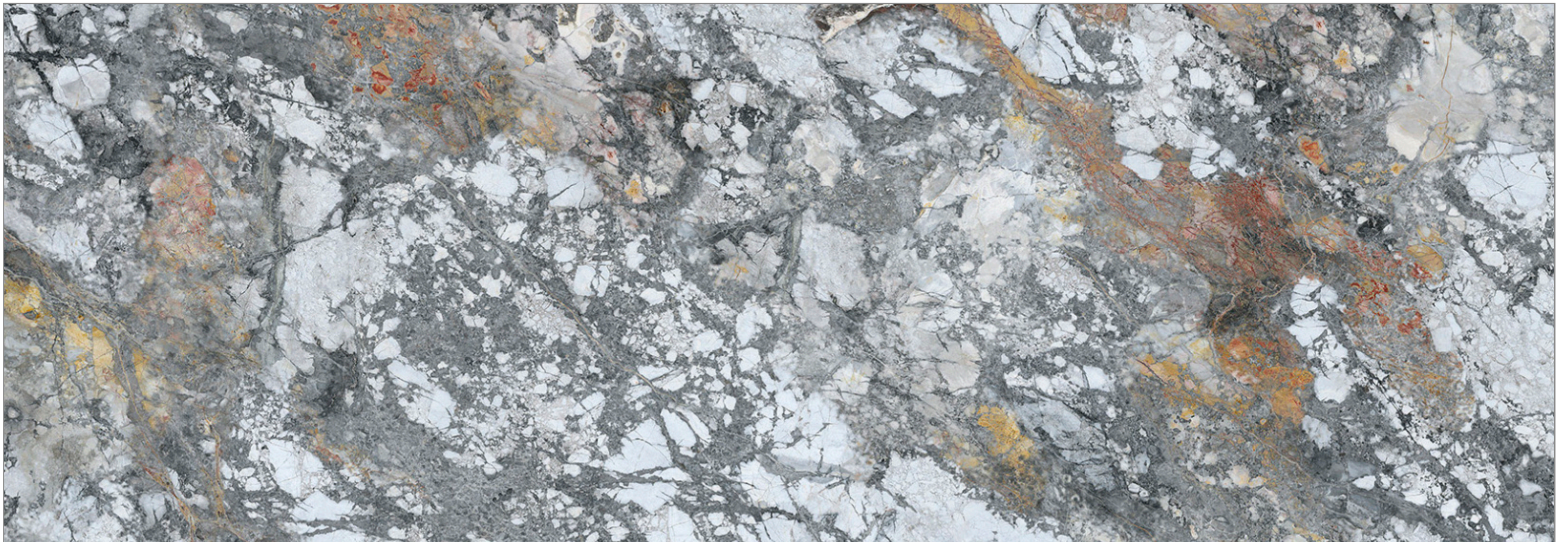

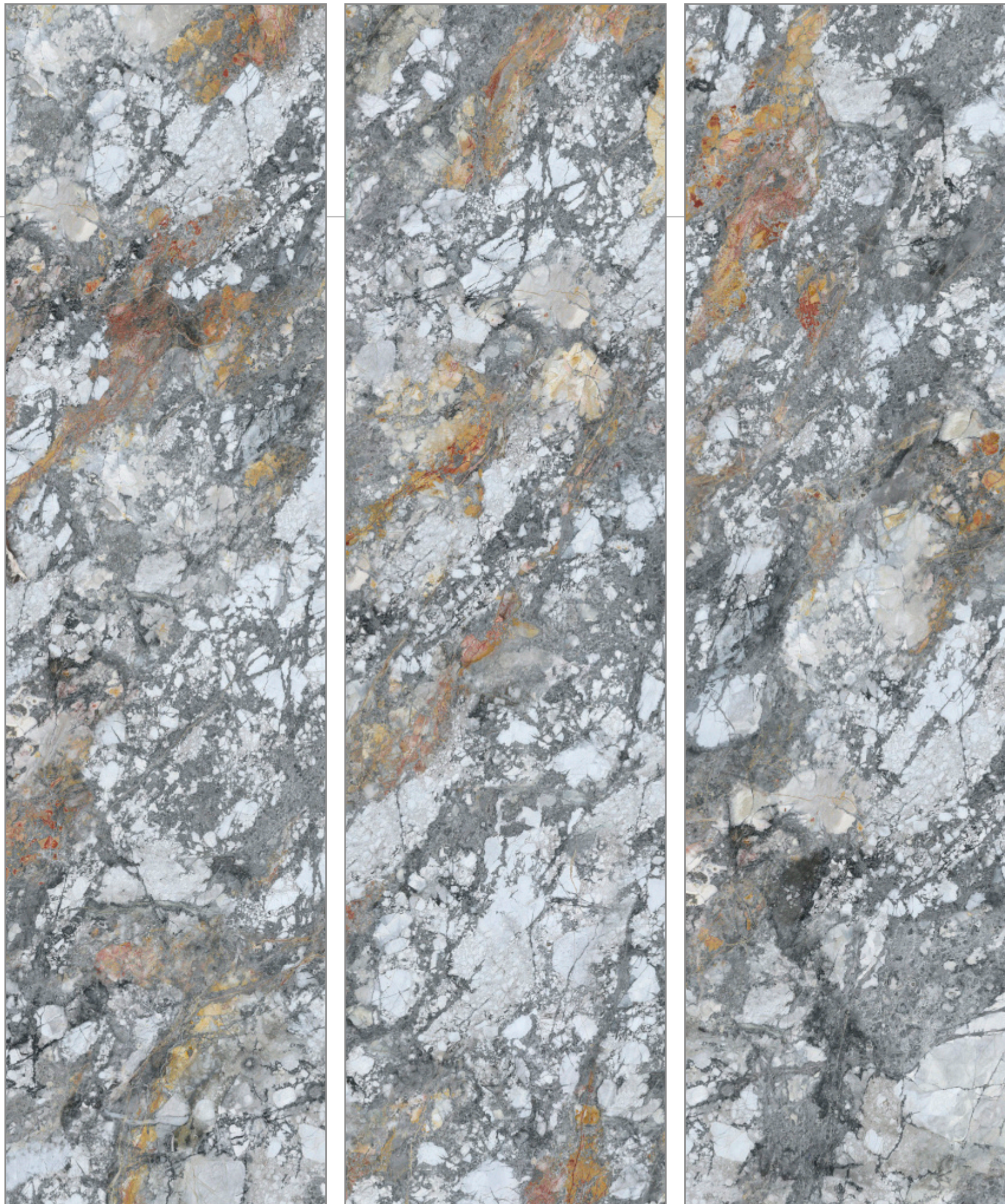

WHITE
BODY

ROCK

| MYSTIC ROCK

FINISH • HIGH GLOSSY
THICKNESS • 15 MM
RANDOM • 3
AVAILABLE SIZES •

80X
240 CM

80X
300 CM

80X
320 CM

 BACK TO
INDEX





| ONYX GREY

● WHITE BODY

| GLOSSY

| 80X240 CM / 80X300 CM / 80X320 CM

WHITE
BODY

ROCK

Soft white layers enhanced with natural marble-like veins
create a surface that feels radiant and refined.

Crafted for surfaces that embody timeless luxury.

| ONYX GREY

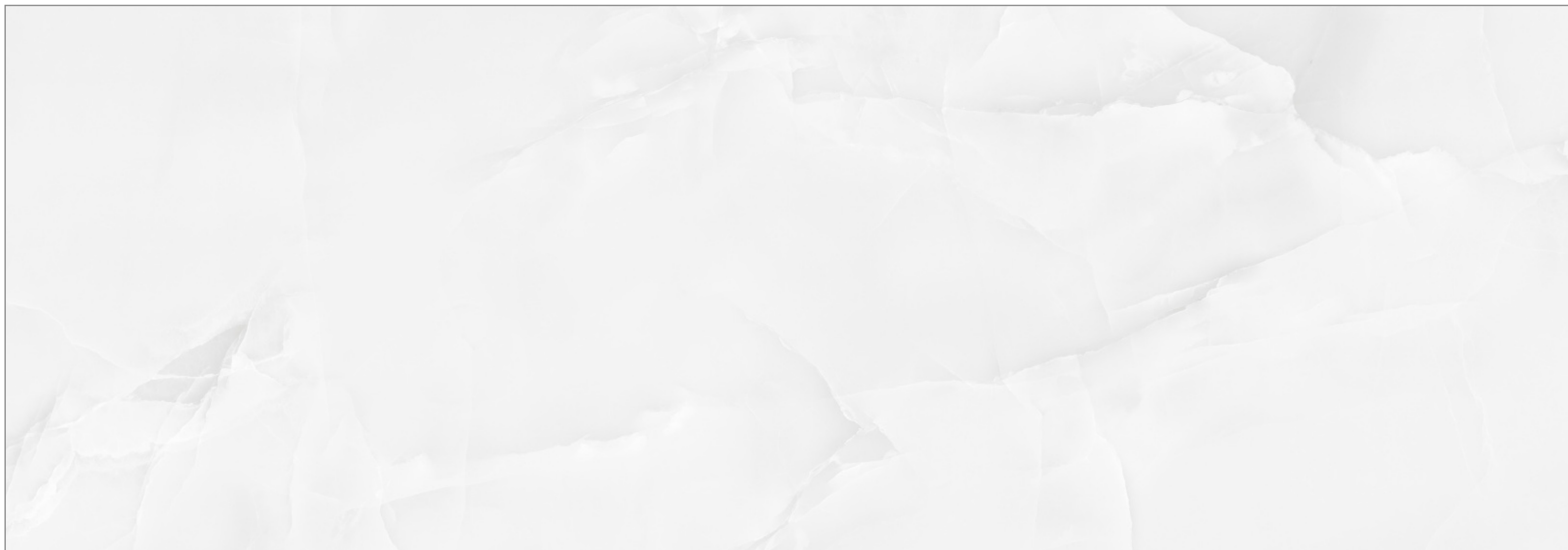

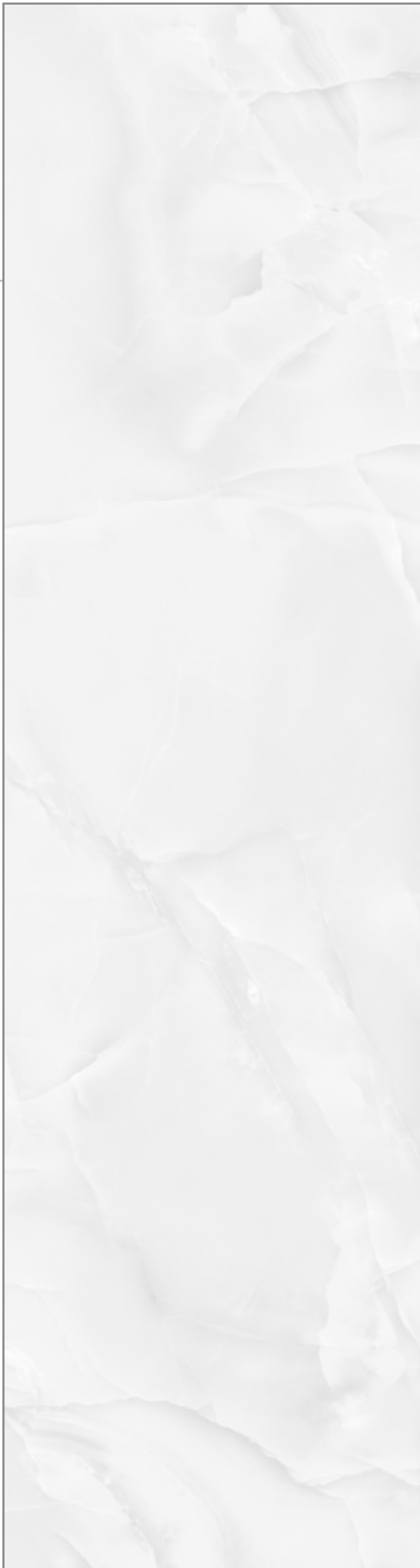
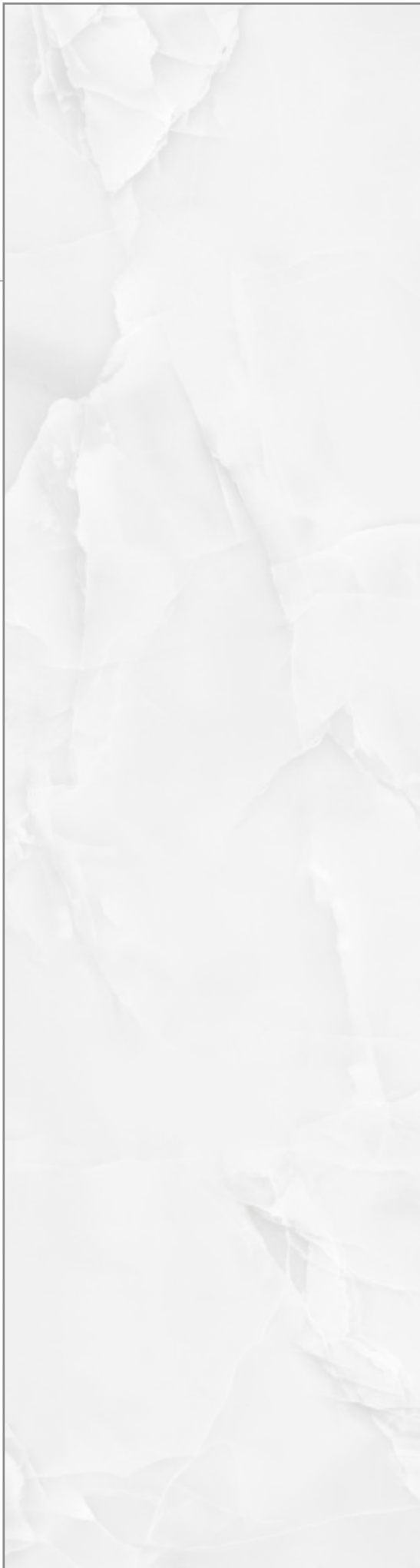

 **WHITE
BODY**

ROCK

| **ONYX GREY**

FINISH • GLOSSY
THICKNESS • 15 MM
RANDOM • 3
AVAILABLE SIZES •

80X
240 CM

80X
300 CM

80X
320 CM

 **BACK TO
INDEX**





HOT CHOCOLATE 3-40
TEA 3-60

| ONYX AMBRA

● WHITE BODY

| GLOSSY

| 80X240 CM / 80X300 CM / 80X320 CM

Soft white surfaces layered with delicate veining
create a surface that feels pristine and elevated.

Designed for spaces that embody quiet luxury.

| ONYX AMBRA



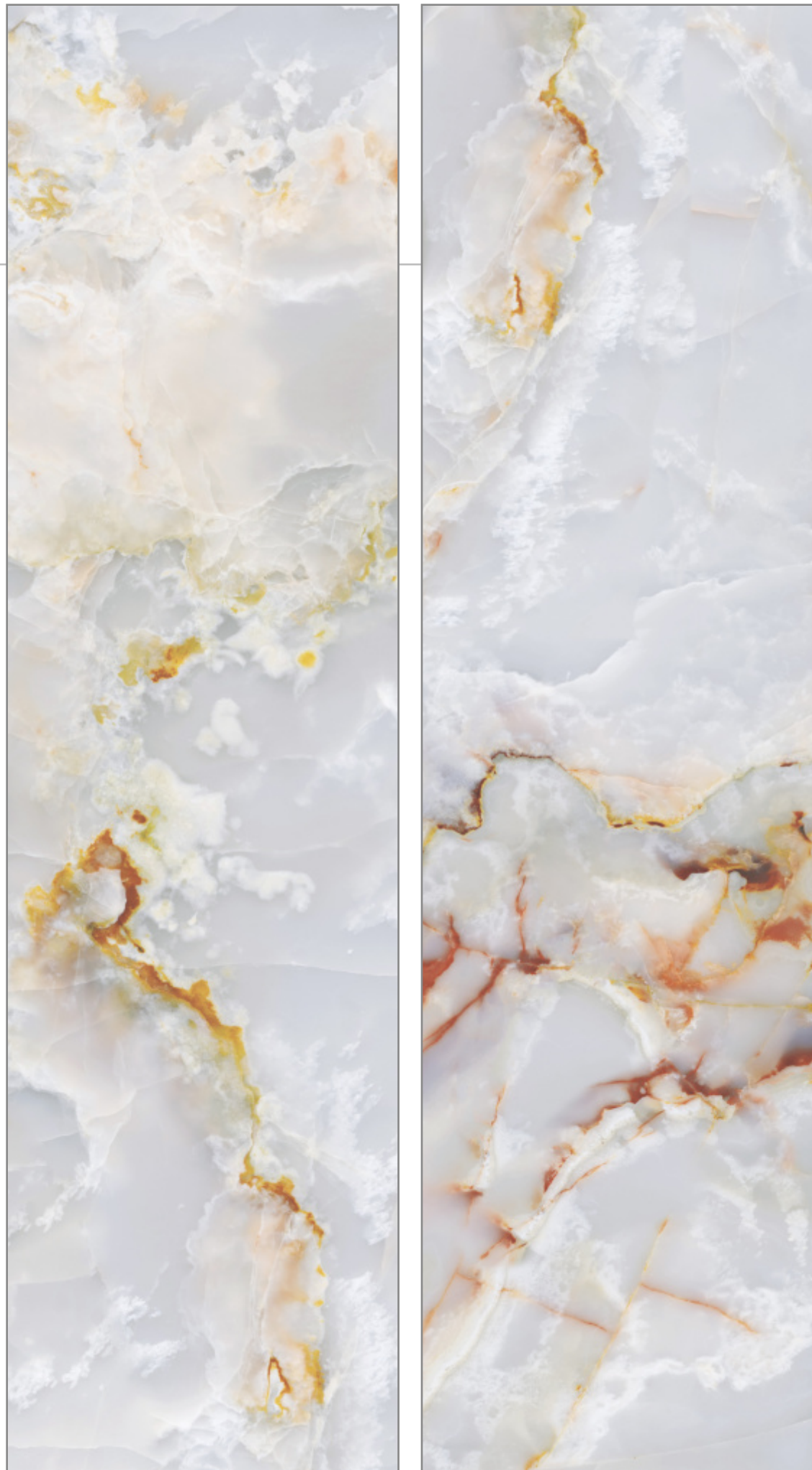

WHITE
BODY

ROCK

| ONYX AMBRA

FINISH • GLOSSY
THICKNESS • 15 MM
RANDOM • 2
AVAILABLE SIZES •

80X
240 CM

80X
300 CM

80X
320 CM

 BACK TO
INDEX





| PEARL ONYX

● WHITE BODY

| GLOSSY

| 80X240 CM / 80X300 CM / 80X320 CM

Whispering white tones create
a surface that feels serene & powerful.

A vision of effortless luxury.

| PEARL ONYX

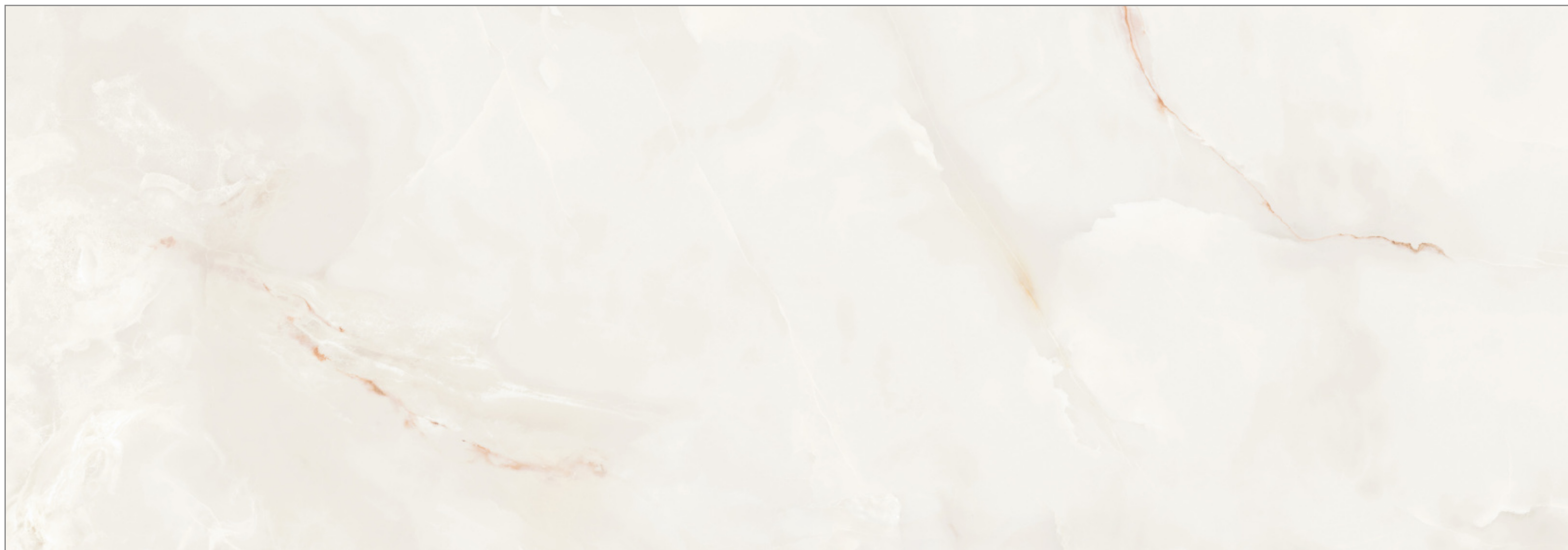



**WHITE
BODY**

ROCK

| PEARL ONYX

FINISH • GLOSSY
THICKNESS • 15 MM
RANDOM • 3
AVAILABLE SIZES •

80X
240 CM

80X
300 CM

80X
320 CM

 **BACK TO
INDEX**





| RADIANCE WHITE

● WHITE BODY

| GLOSSY

| 80X240 CM / 80X300 CM / 80X320 CM

Smooth, luminous white layers flow with delicate veining,
creating surfaces that feel effortlessly elegant.

Made for those who appreciate understated luxury.

| RADIANCE WHITE





WHITE
BODY

ROCK

| RADIANCE WHITE

FINISH • GLOSSY
THICKNESS • 15 MM
RANDOM • 3
AVAILABLE SIZES •

80X
240 CM

80X
300 CM

80X
320 CM

 BACK TO
INDEX





| REGAL STATUARIO

● WHITE BODY

| GLOSSY

| 80X240 CM / 80X300 CM / 80X320 CM

Shimmering white surfaces, patterned with gentle veins,
create a presence that feels bright yet refined.

Made for surfaces where elegance is natural, not forced.

| REGAL STATUARIO





**WHITE
BODY**

ROCK

| REGAL STATUARIO

FINISH • GLOSSY
THICKNESS • 15 MM
RANDOM • 3
AVAILABLE SIZES •

80X
240 CM

80X
300 CM

80X
320 CM

 **BACK TO
INDEX**





| SERENA WHITE

● WHITE BODY

| GLOSSY

| 80X240 CM / 80X300 CM / 80X320 CM

Soft white marble-inspired layers polished to a gentle shine
create surfaces that feel light, fluid, and luxurious.

Crafted to celebrate elegance in its purest form.

| SERENA WHITE

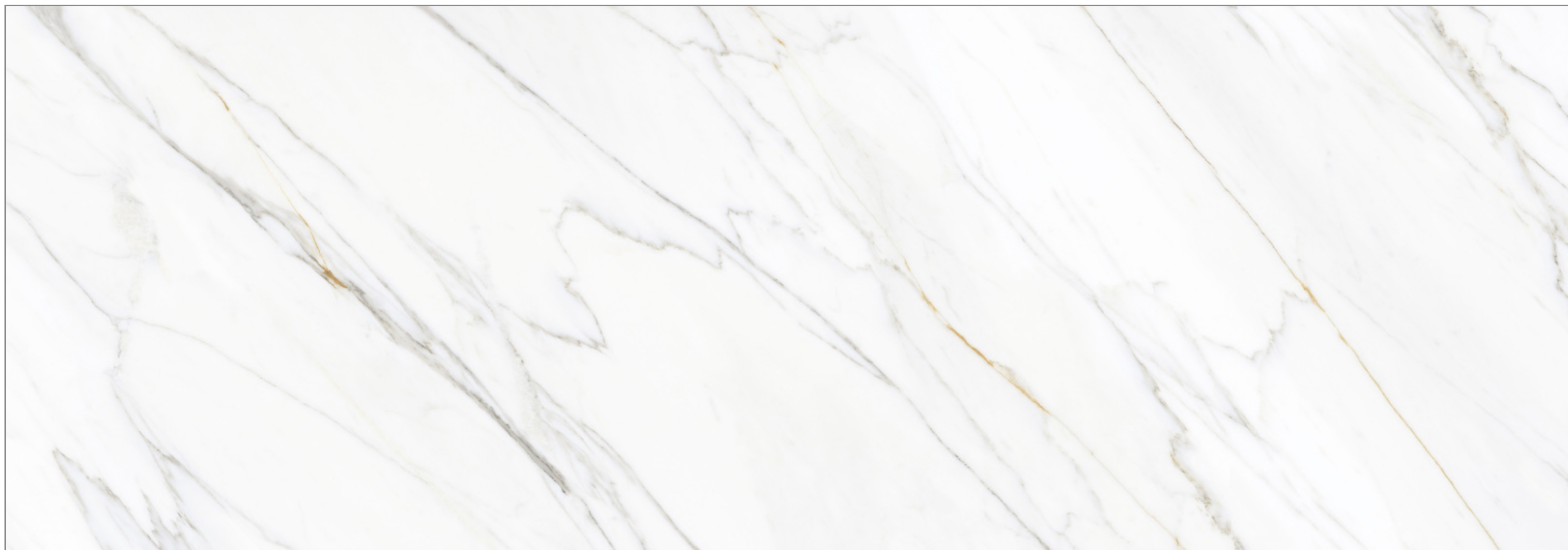



**WHITE
BODY**

ROCK

| SERENA WHITE

FINISH • GLOSSY
THICKNESS • 15 MM
RANDOM • 3
AVAILABLE SIZES •

80X
240 CM

80X
300 CM

80X
320 CM

 **BACK TO
INDEX**





| STATUARIO ELEGANTE

● WHITE BODY

| GLOSSY

| 80X240 CM / 80X300 CM / 80X320 CM

Luminous white surfaces, kissed by subtle veining,
create a look that feels serene yet commanding.

Where simplicity meets refinement.

| STATUARIO ELEGANTE





**WHITE
BODY**

ROCK

| STATUARIO ELEGANTE

FINISH • GLOSSY
THICKNESS • 15 MM
RANDOM • 3
AVAILABLE SIZES •

80X
240 CM

80X
300 CM

80X
320 CM

 **BACK TO
INDEX**





| STATUARIO EUROPA

● WHITE BODY

| GLOSSY

| 80X240 CM / 80X300 CM / 80X320 CM

White surfaces flow with subtle natural patterns,
capturing light and sophistication in every curve.

Made to inspire quiet luxury.

| STATUARIO EUROPA

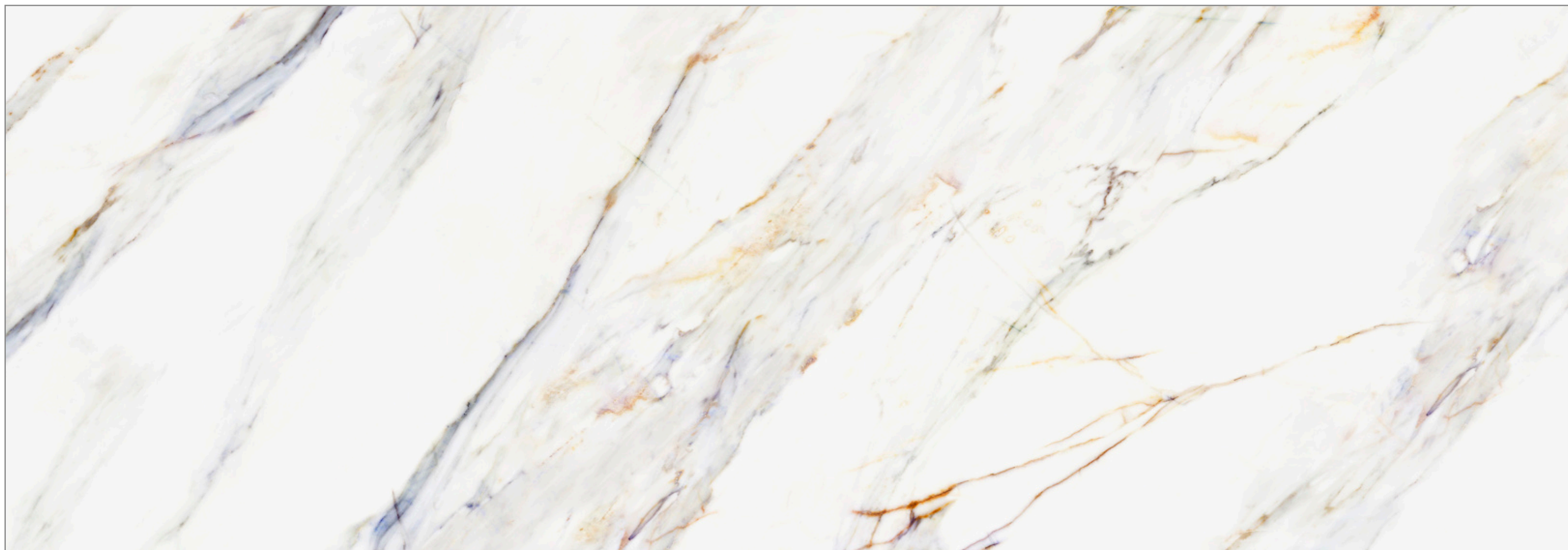



WHITE
BODY

ROCK

| STATUARIO EUROPA

FINISH • GLOSSY
THICKNESS • 15 MM
RANDOM • 3
AVAILABLE SIZES •

80X
240 CM

80X
300 CM

80X
320 CM

 BACK TO
INDEX





A luminous white canvas creates
surfaces that feel natural, fluid, and premium.

Crafted to embody enduring elegance.

| STATUARIO ITALIA





**WHITE
BODY**

ROCK

| STATUARIO ITALIA

FINISH • GLOSSY
THICKNESS • 15 MM
RANDOM • 3
AVAILABLE SIZES •

80X
240 CM

80X
300 CM

80X
320 CM

 **BACK TO
INDEX**



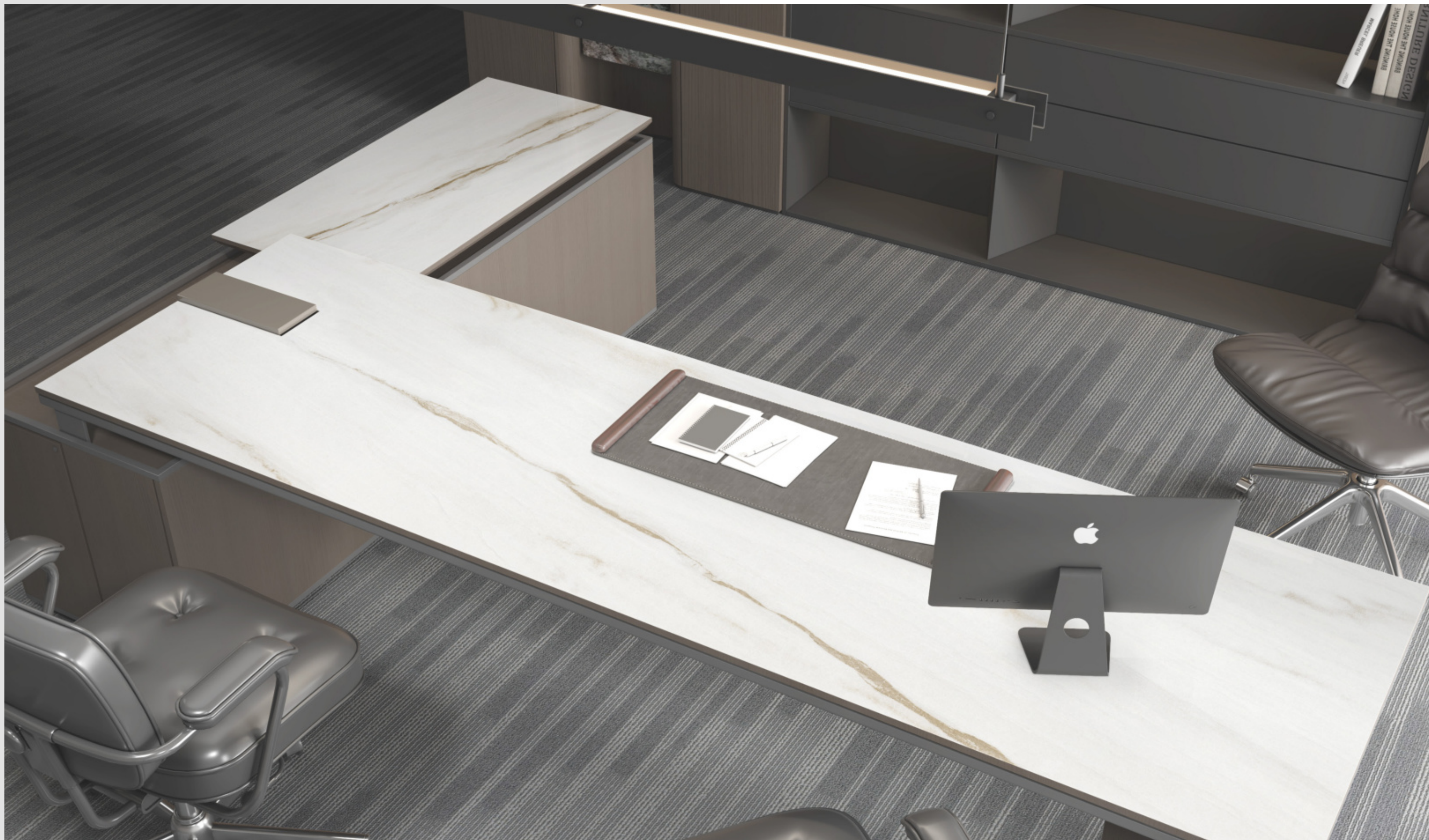

| STATUARIO VELA

● WHITE BODY

| GLOSSY

| 80X240 CM / 80X300 CM / 80X320 CM

Subtle natural forms sweep across white surfaces,
creating a look that is sophisticated, luminous, and serene.

Made for moments of understated elegance.

| STATUARIO VELA





 **WHITE
BODY**

ROCK

| **STATUARIO VELA**

FINISH • GLOSSY
THICKNESS • 15 MM
RANDOM • 3
AVAILABLE SIZES •

80X
240 CM

80X
300 CM

80X
320 CM

 **BACK TO
INDEX**





| THUNDER WHITE

● WHITE BODY

| GLOSSY

| 80X240 CM / 80X300 CM / 80X320 CM

A radiant white foundation flows with natural rhythm,
creating surfaces that feel soft and luminous.

Designed for interiors that speak confidence.

| THUNDER WHITE





 **WHITE
BODY**

ROCK

| **THUNDER WHITE**

FINISH • GLOSSY
THICKNESS • 15 MM
RANDOM • 3
AVAILABLE SIZES •

80X
240 CM

80X
300 CM

80X
320 CM

 **BACK TO
INDEX**





| VENEZIA SKY

● WHITE BODY

| GLOSSY

| 80X240 CM / 80X300 CM / 80X320 CM

Layered stone-grey textures, softly articulated,
offer surfaces that feel refined and enduring.

Made for spaces where design tells a quiet story.

| VENEZIA SKY



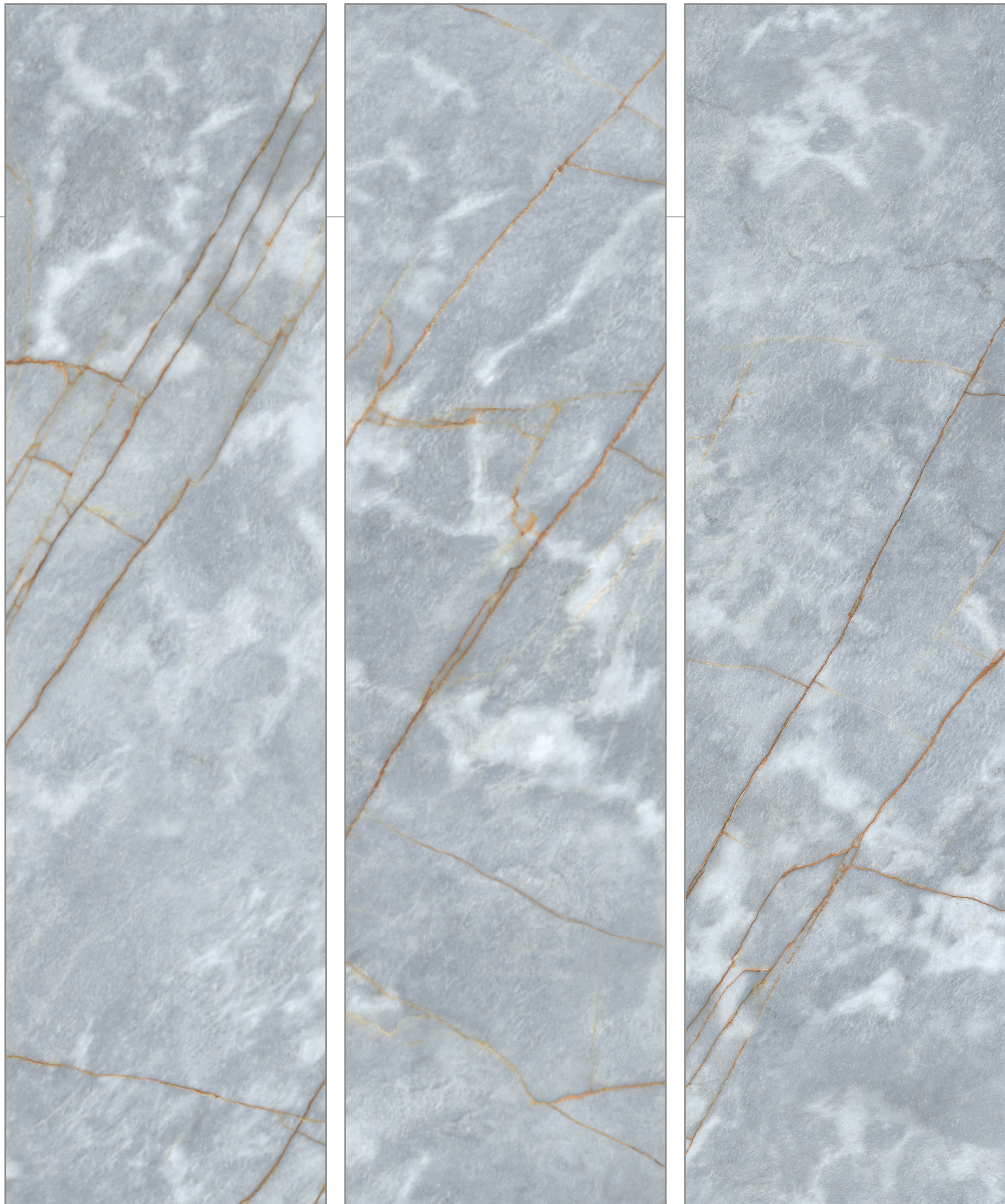

**WHITE
BODY**

ROCK

| VENEZIA SKY

FINISH • GLOSSY
THICKNESS • 15 MM
RANDOM • 3
AVAILABLE SIZES •

80X
240 CM

80X
300 CM

80X
320 CM

 **BACK TO
INDEX**





| WHITE PANDA

● WHITE BODY

| HIGH GLOSSY

| 80X240 CM / 80X300 CM / 80X320 CM

Soft white tones create a
surface that feels serene & commanding.

A statement of timeless elegance.

| WHITE PANDA





WHITE
BODY

ROCK

| WHITE PANDA

FINISH • HIGH GLOSSY
THICKNESS • 15 MM
RANDOM • 3
AVAILABLE SIZES •

80X
240 CM

80X
300 CM

80X
320 CM

 BACK TO
INDEX



The image features a background of layered, textured paper in various shades of beige and cream. A prominent diagonal crease separates a darker, more textured paper on the left from a lighter, smoother paper on the right. A faint, light gray grid pattern is visible on the right side of the image. In the bottom left corner, the logo for 'IVORY BODY' is displayed. The logo consists of a stylized icon of a vertical line with a diagonal tick mark at the top, followed by the words 'IVORY' and 'BODY' stacked vertically in a bold, sans-serif font.

IVORY
BODY



| AVORIO CREMA

● IVORY BODY

| GLOSSY

| 80X240 CM / 80X300 CM / 80X320 CM

Ivory surfaces inspired by morning light
bring a sense of openness and effortless calm.

Created for spaces that feel serene from the first glance.

| AVORIO CREMA





**IVORY
BODY**

ROCK

| AVORIO CREMA

FINISH • GLOSSY
THICKNESS • 15 MM
RANDOM • 3
AVAILABLE SIZES •

80X
240 CM

80X
300 CM

80X
320 CM

 **BACK TO
INDEX**





| BLUE BRECCIA

● IVORY BODY

| GLOSSY

| 80X240 CM / 80X300 CM / 80X320 CM

Ivory interpreted through a modern
lens offers clarity and visual peace.

For spaces that seek balance over excess.

| BLUE BRECCIA





IVORY
BODY

ROCK

| BLUE BRECCIA

FINISH • GLOSSY
THICKNESS • 15 MM
RANDOM • 3
AVAILABLE SIZES •

80X
240 CM

80X
300 CM

80X
320 CM

 BACK TO
INDEX





| DYNA ROYAL

● IVORY BODY

| GLOSSY

| 80X240 CM / 80X300 CM / 80X320 CM

Ivory-toned depths enhanced by a polished gloss
create a surface that feels luminous and sophisticated.

Perfect for spaces that embrace modern luxury.

| DYNA ROYAL





IVORY
BODY

ROCK

| DYNA ROYAL

FINISH • GLOSSY
THICKNESS • 15 MM
RANDOM • 3
AVAILABLE SIZES •

80X
240 CM

80X
300 CM

80X
320 CM

 BACK TO
INDEX





| EXOTIC GOLD

● IVORY BODY

| HIGH GLOSSY

| 80X240 CM / 80X300 CM / 80X320 CM

Light-toned ivory finishes evoke air,
space, and gentle warmth.

Perfect for environments that breathe simplicity.

| EXOTIC GOLD





IVORY
BODY

ROCK

| EXOTIC GOLD

FINISH • HIGH GLOSSY
THICKNESS • 15 MM
RANDOM • 3
AVAILABLE SIZES •

80X
240 CM

80X
300 CM

80X
320 CM

 BACK TO
INDEX





| MARMO ONYX

● IVORY BODY

| GLOSSY

| 80X240 CM / 80X300 CM / 80X320 CM

A smooth ivory base finished with gentle shine
creates a surface that feels bright and expansive.

Designed for spaces that express effortless style.

| MARMO ONYX



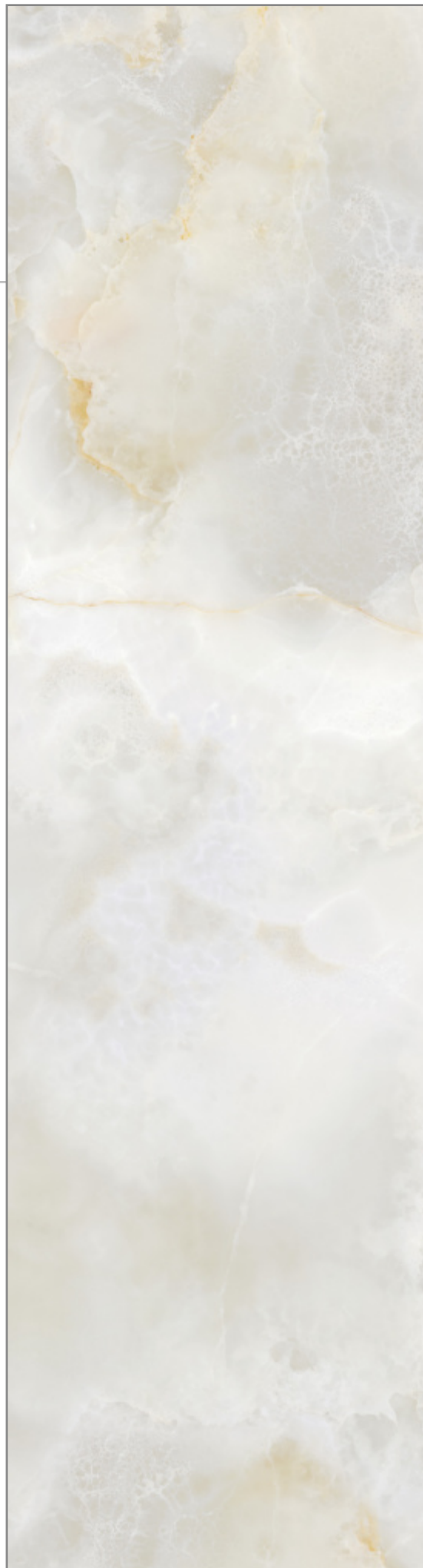

**IVORY
BODY**

ROCK

| MARMO ONYX

FINISH • GLOSSY
THICKNESS • 15 MM
RANDOM • 3
AVAILABLE SIZES •

80X
240 CM

80X
300 CM

80X
320 CM

 **BACK TO
INDEX**





| ONYX GOLD

● IVORY BODY

| GLOSSY

| 80X240 CM / 80X300 CM / 80X320 CM

Clean ivory tones reflect natural
light to create an atmosphere of calm luxury.
Designed for spaces that feel endlessly graceful.

| ONYX GOLD

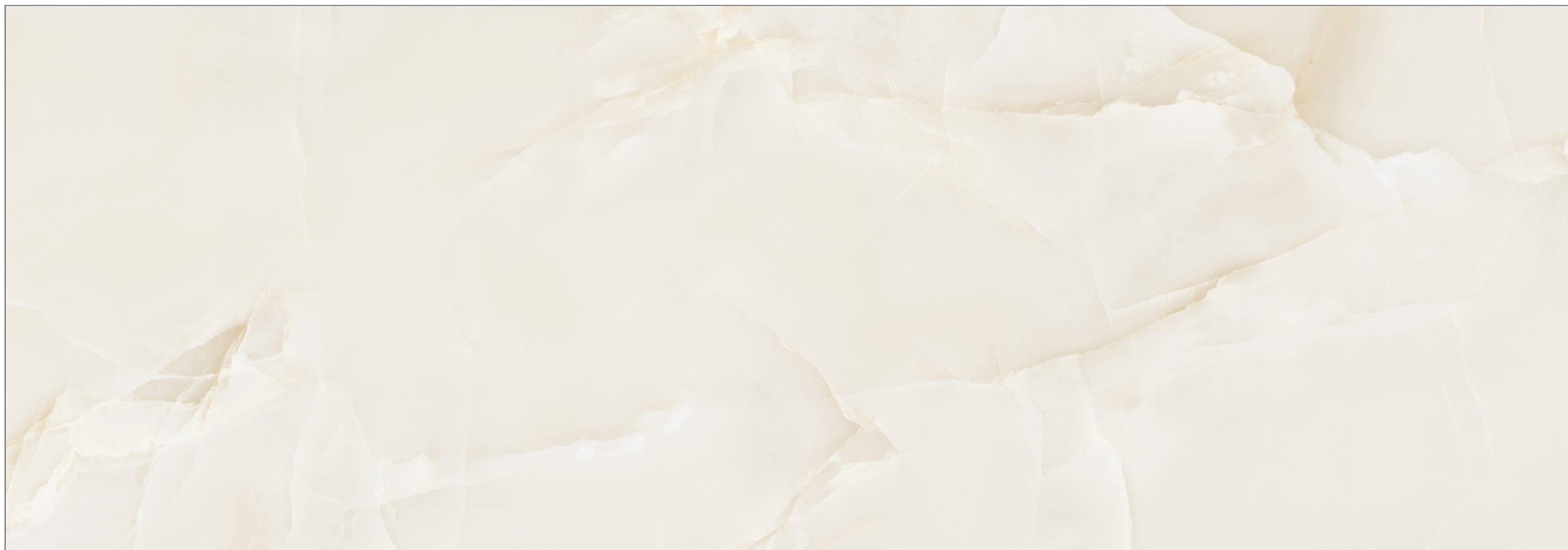



IVORY
BODY

ROCK

| ONYX GOLD

FINISH • GLOSSY
THICKNESS • 15 MM
RANDOM • 3
AVAILABLE SIZES •

80X
240 CM

80X
300 CM

80X
320 CM

 BACK TO
INDEX





| POLAR BEIGE

● IVORY BODY

| GLOSSY

| 80X240 CM / 80X300 CM / 80X320 CM

A soft ivory body paired with a glossy finish creates
a surface that reflects light with graceful clarity.

Designed to glow with refined elegance.

| POLAR BEIGE





IVORY
BODY

ROCK

| POLAR BEIGE

FINISH • GLOSSY
THICKNESS • 15 MM
RANDOM • 3
AVAILABLE SIZES •

80X
240 CM

80X
300 CM

80X
320 CM

 BACK TO
INDEX





| ROMAN TRAVERTINE

● IVORY BODY

| GLOSSY

| 80X240 CM / 80X300 CM / 80X320 CM

A smooth ivory base finished with gentle shine
creates a surface that feels bright and expansive.

Crafted for timeless elegance.

| ROMAN TRAVERTINE





IVORY
BODY

ROCK

| ROMAN TRAVERTINE

FINISH • GLOSSY
THICKNESS • 15 MM
RANDOM • 3
AVAILABLE SIZES •

80X
240 CM

80X
300 CM

80X
320 CM

 BACK TO
INDEX





| SUPREMO BEIGE

● IVORY BODY | GLOSSY | 80X240 CM / 80X300 CM / 80X320 CM

A refined ivory foundation elevated through glossy
brilliance creates a surface that feels airy and premium.

Created for enduring beauty.

| SUPREMO BEIGE

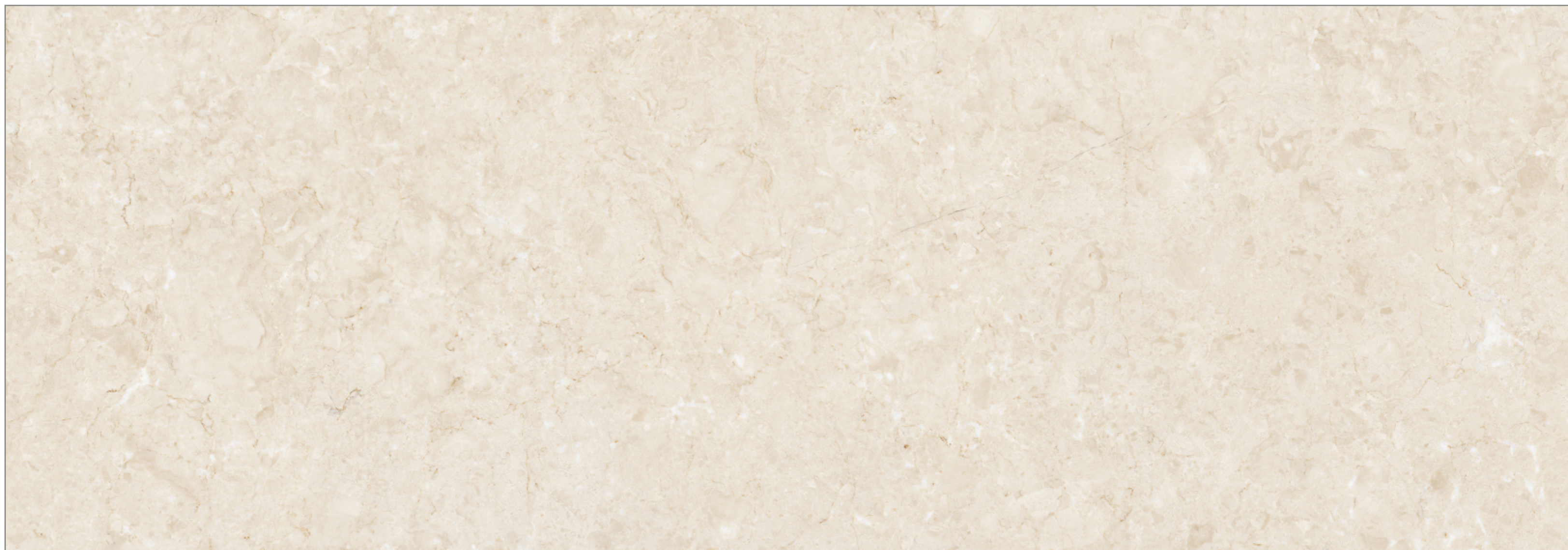



**IVORY
BODY**

ROCK

| SUPREMO BEIGE

FINISH • GLOSSY
THICKNESS • 15 MM
RANDOM • 3
AVAILABLE SIZES •

80X
240 CM

80X
300 CM

80X
320 CM

 **BACK TO
INDEX**





| TAJ NUEVA

● IVORY BODY

| GLOSSY

| 80X240 CM / 80X300 CM / 80X320 CM

Ivory-inspired tones finished with a subtle sheen
create a surface that feels radiant and classic.

Designed for pure sophistication.

| TAJ NUEVA





IVORY
BODY

ROCK

| TAJ NUEVA

FINISH • GLOSSY
THICKNESS • 15 MM
RANDOM • 2
AVAILABLE SIZES •

80X
240 CM

80X
300 CM

80X
320 CM

 BACK TO
INDEX



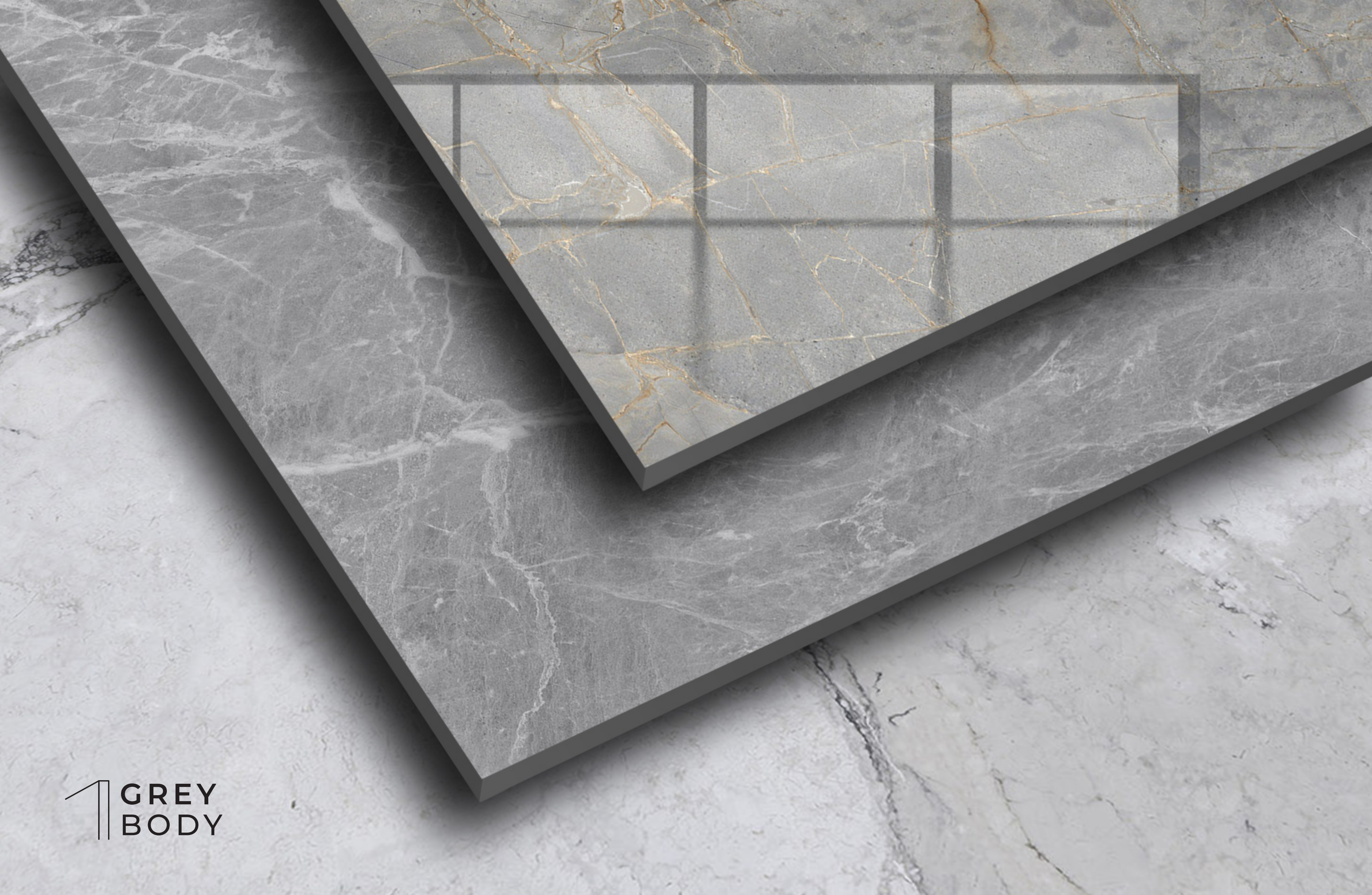

 **GREY
BODY**



| ARMANI GREY

● GREY BODY

| GLOSSY

| 80X240 CM / 80X300 CM / 80X320 CM

Subtle grey tones layered with architectural depth
shape surfaces that exude quiet confidence.

Designed for spaces that embrace enduring style.

| ARMANI GREY

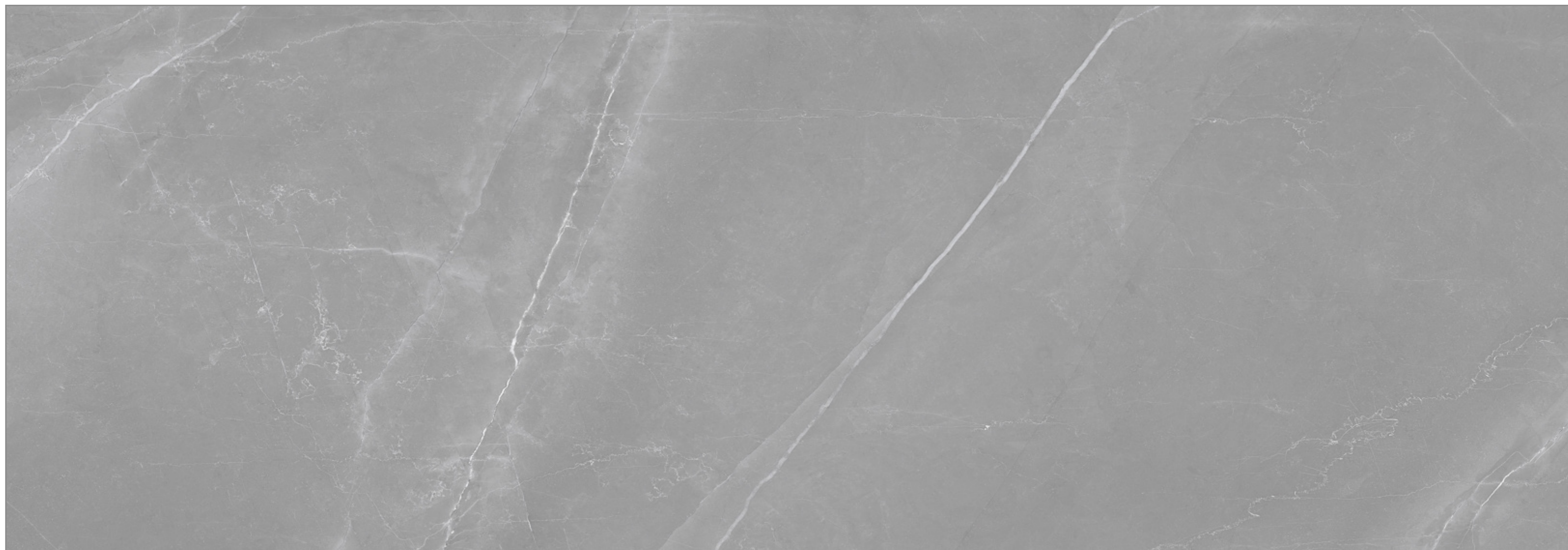



 GREY
BODY

ROCK

| ARMANI GREY

FINISH • GLOSSY
THICKNESS • 15 MM
RANDOM • 3
AVAILABLE SIZES •

80X
240 CM

80X
300 CM

80X
320 CM

 BACK TO
INDEX





| CAPRON GREY

● GREY BODY

| GLOSSY

| 80X240 CM / 80X300 CM / 80X320 CM

Deep ash hues shaped by subtle veining
create a surface that feels modern and timeless.

Perfect for spaces that reflect understated elegance.

| CAPRON GREY





 GREY
BODY

ROCK

| **CAPRON GREY**

FINISH • GLOSSY
THICKNESS • 15 MM
RANDOM • 3
AVAILABLE SIZES •

80X
240 CM

80X
300 CM

80X
320 CM

 **BACK TO
INDEX**





| LIMER GREY

● GREY BODY

| GLOSSY

| 80X240 CM / 80X300 CM / 80X320 CM

Gentle stone-grey shades meet restrained textures
creating surfaces that are both calm and composed.

Made for environments that value lasting quality.

| LIMER GREY





 GREY
BODY

ROCK

| **LIMER GREY**

FINISH • GLOSSY
THICKNESS • 15 MM
RANDOM • 3
AVAILABLE SIZES •

80X
240 CM

80X
300 CM

80X
320 CM

 **BACK TO
INDEX**





| PIETRA GREY

● GREY BODY

| GLOSSY

| 80X240 CM / 80X300 CM / 80X320 CM

Muted stone-grey tones blended with subtle textures
create a surface that feels calm and architectural.

Crafted for spaces that value timeless design.

| PIETRA GREY

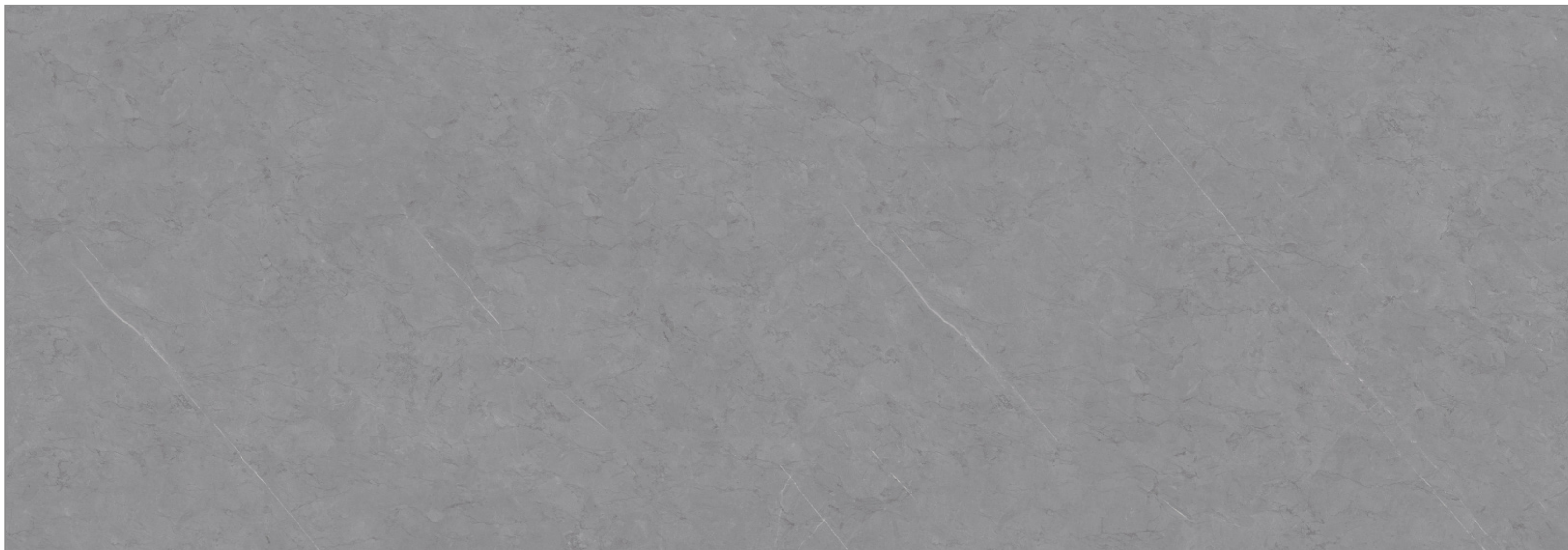

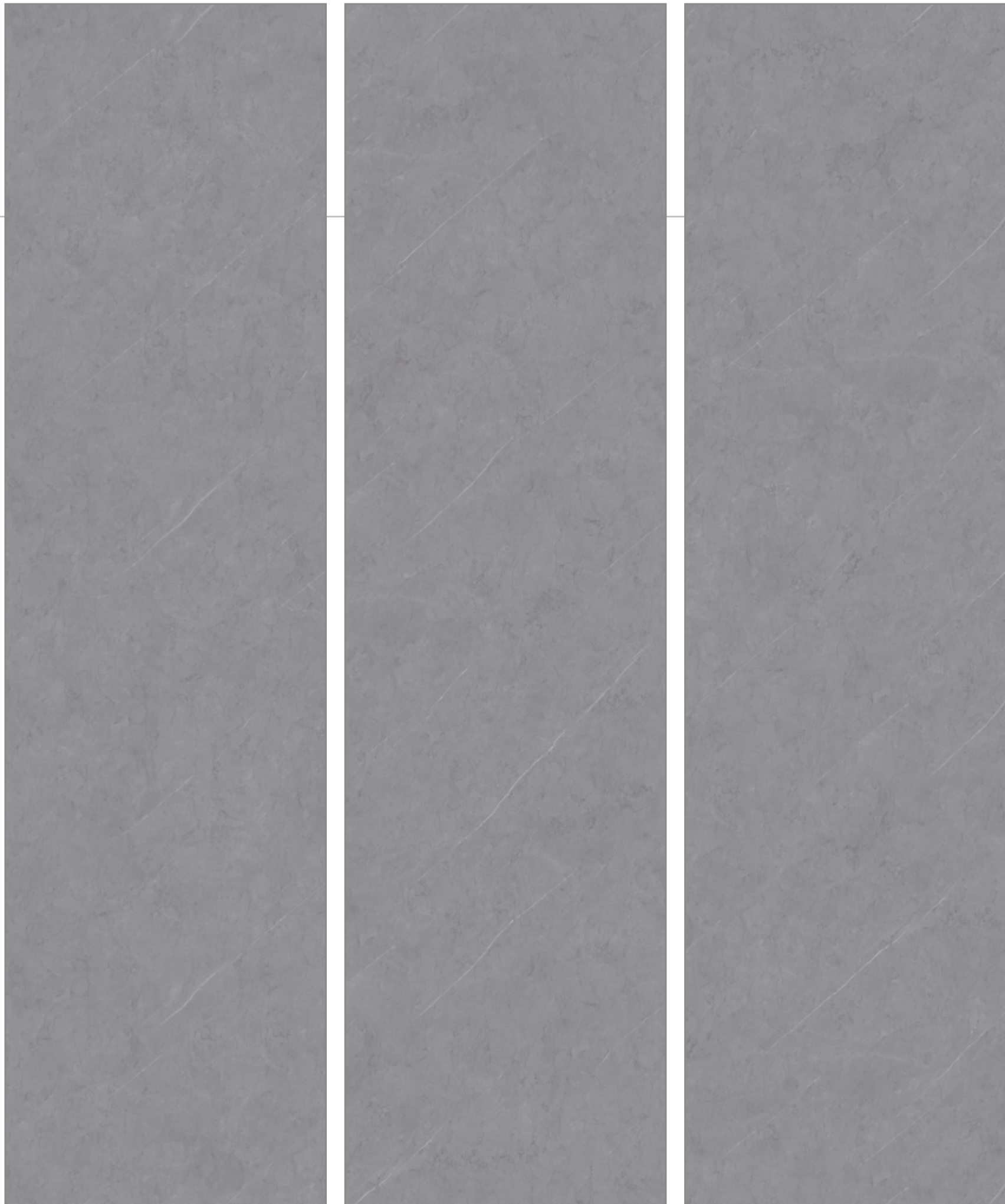

 GREY
BODY

ROCK

| PIETRA GREY

FINISH • GLOSSY
THICKNESS • 15 MM
RANDOM • 3
AVAILABLE SIZES •

80X
240 CM

80X
300 CM

80X
320 CM

 BACK TO
INDEX





| ROMAN TRAVERTINE SILVER

● GREY BODY

| GLOSSY

| 80X240 CM / 80X300 CM / 80X320 CM

Deep graphite hues flowing with gentle veining create a surface that feels bold and composed.

Made for spaces that reflect confident minimalism.

| ROMAN TRAVERTINE SILVER



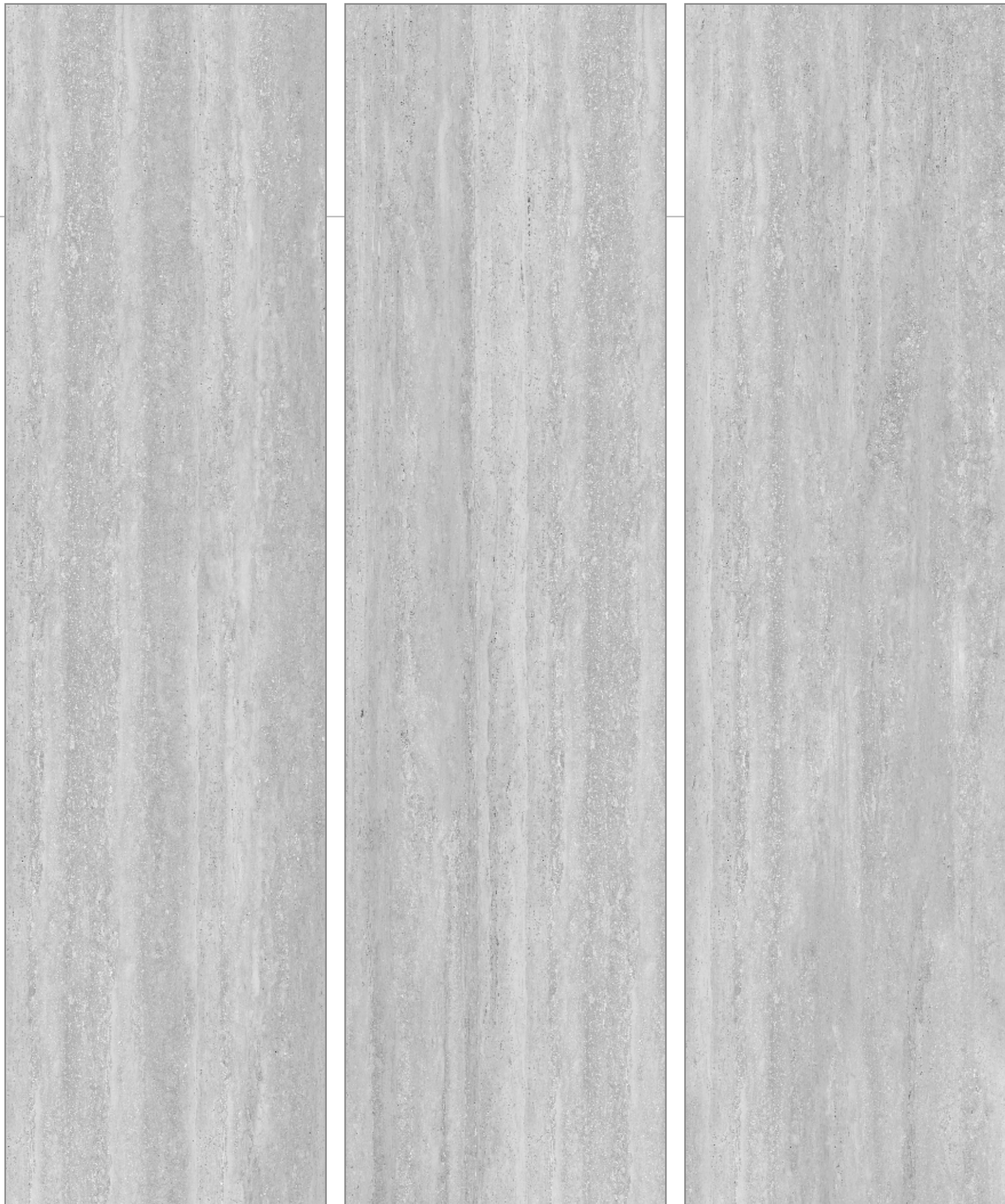

 GREY
BODY

ROCK

| ROMAN TRAVERTINE
SILVER

FINISH • GLOSSY
THICKNESS • 15 MM
RANDOM • 3
AVAILABLE SIZES •

80X
240 CM

80X
300 CM

80X
320 CM

 BACK TO
INDEX





| TIGER ONYX

● GREY BODY

| GLOSSY

| 80X240 CM / 80X300 CM / 80X320 CM

Neutral grey depths refined through delicate detailing create a surface that feels elegant and enduring.

Ideal for spaces where simplicity feels premium.

| TIGER ONYX





 GREY
BODY

ROCK

| TIGER ONYX

FINISH • GLOSSY
THICKNESS • 15 MM
RANDOM • 3
AVAILABLE SIZES •

80X
240 CM

80X
300 CM

80X
320 CM

 BACK TO
INDEX





| VERSACE GOLD

● GREY BODY

| GLOSSY

| 80X240 CM / 80X300 CM / 80X320 CM

Concrete-inspired greys shaped with natural depth
create a surface that feels architectural and strong.

Made for spaces that celebrate modern form.

| VERSACE GOLD



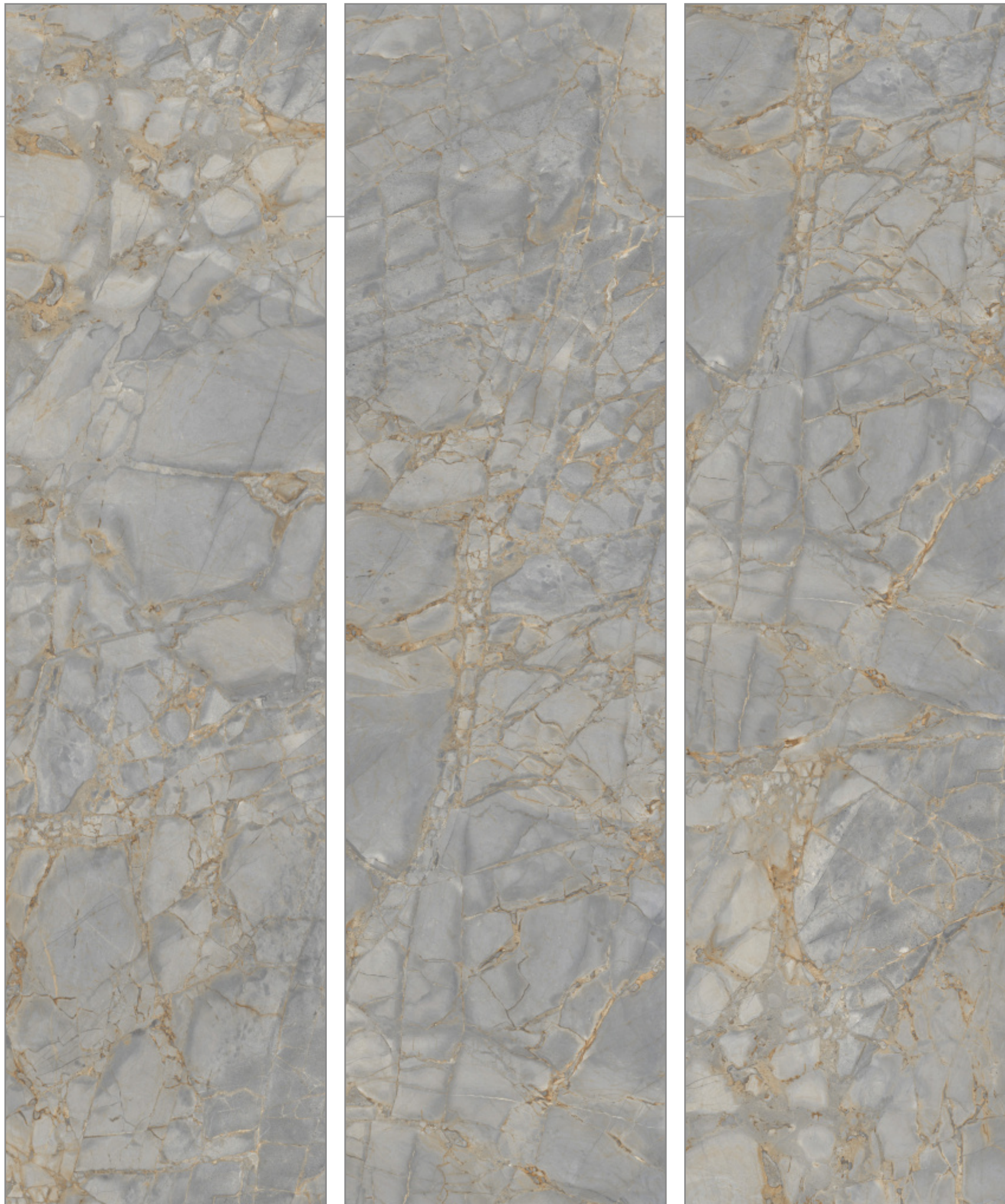

 GREY
BODY



| **VERSACE GOLD**

FINISH • GLOSSY
THICKNESS • 15 MM
RANDOM • 3
AVAILABLE SIZES •

80X
240 CM

80X
300 CM

80X
320 CM

 **BACK TO
INDEX**



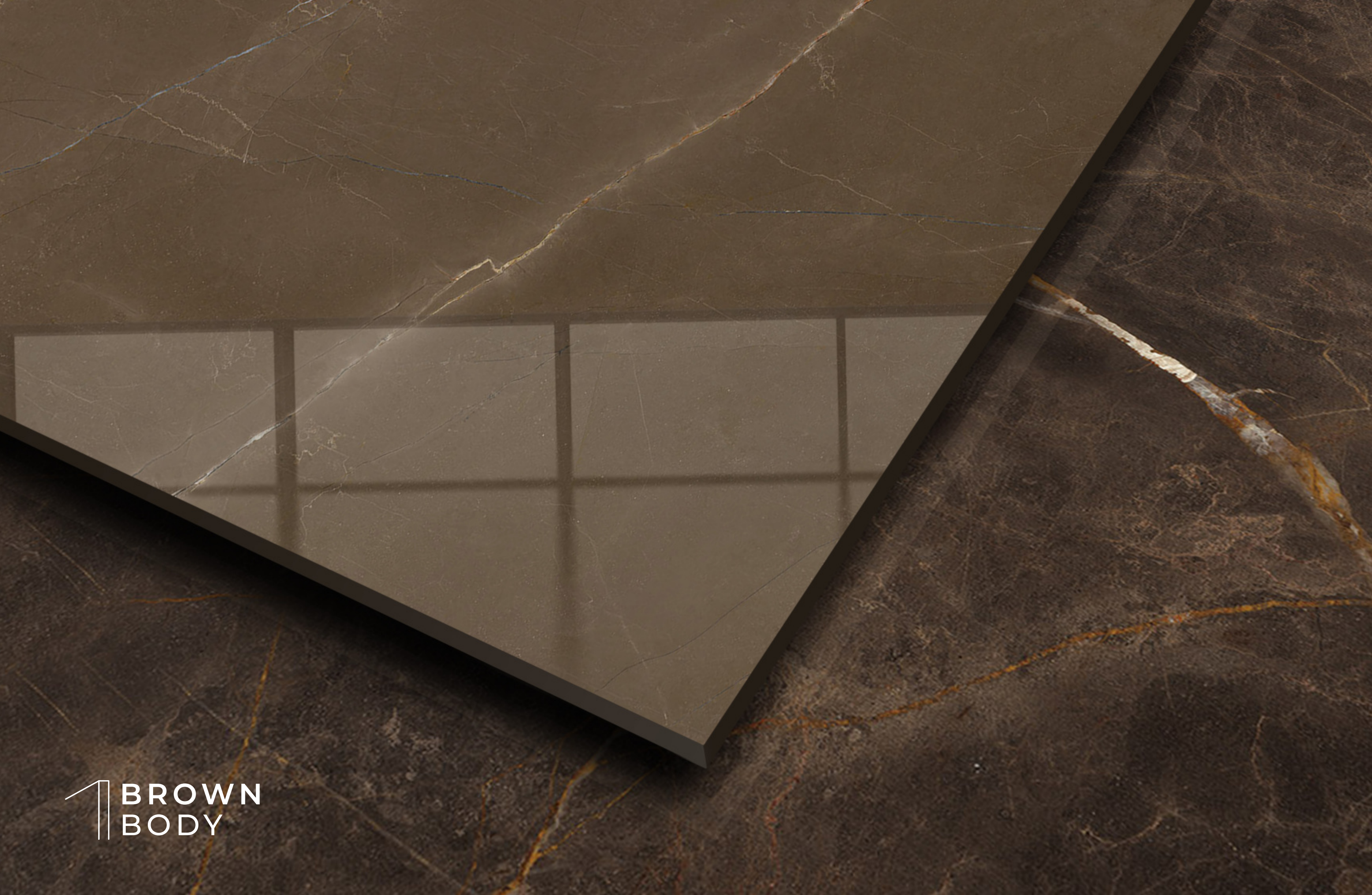

 **BROWN
BODY**



| ARMANI BROWN

● BROWN BODY | HIGH GLOSSY | 80X240 CM / 80X300 CM / 80X320 CM

Natural brown textures intertwined with mineral richness offer a surface that balances warmth with subtle strength.

Made for spaces that feel welcoming yet refined.

| ARMANI BROWN





 **BROWN
BODY**

ROCK

| **ARMANI BROWN**

FINISH • HIGH GLOSSY
THICKNESS • 15 MM
RANDOM • 3
AVAILABLE SIZES •

80X
240 CM

80X
300 CM

80X
320 CM

 **BACK TO
INDEX**





| ELEGANT BRONZE

● BROWN BODY

| HIGH GLOSSY

| 80X240 CM / 80X300 CM / 80X320 CM

Rich earthy hues shaped by subtle veining
create a surface that feels timeless and inviting.

Crafted for spaces that reflect warmth and elegance.

| ELEGANT BRONZE

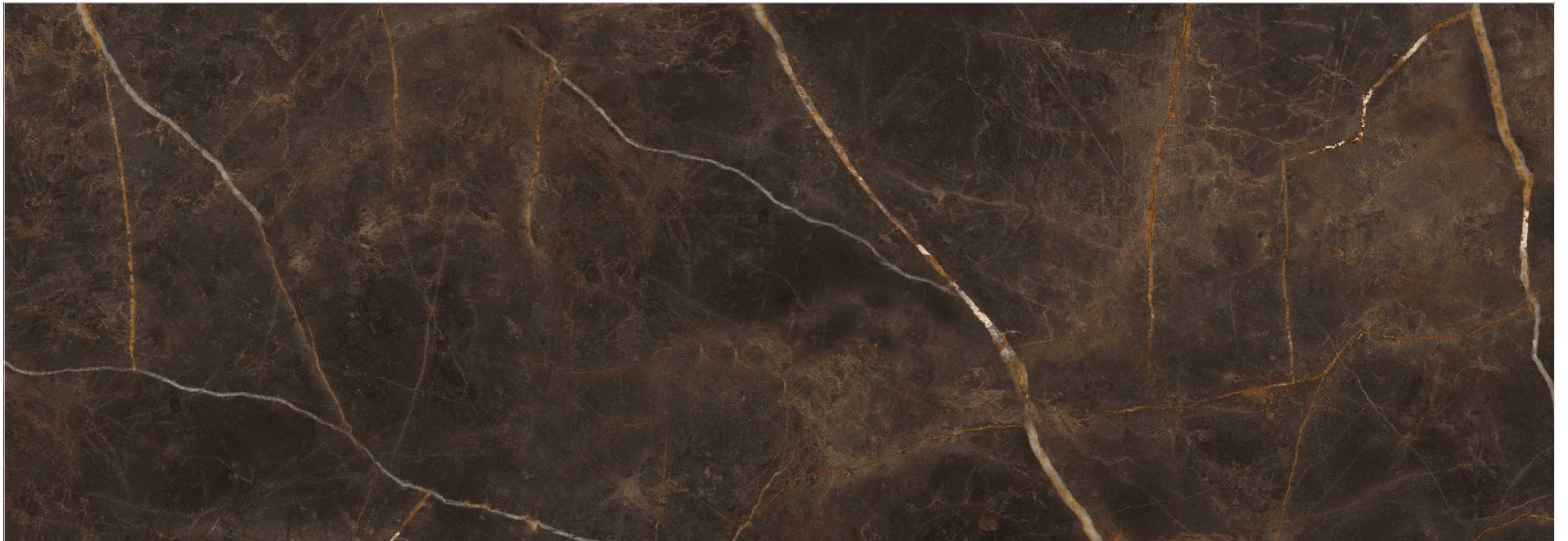

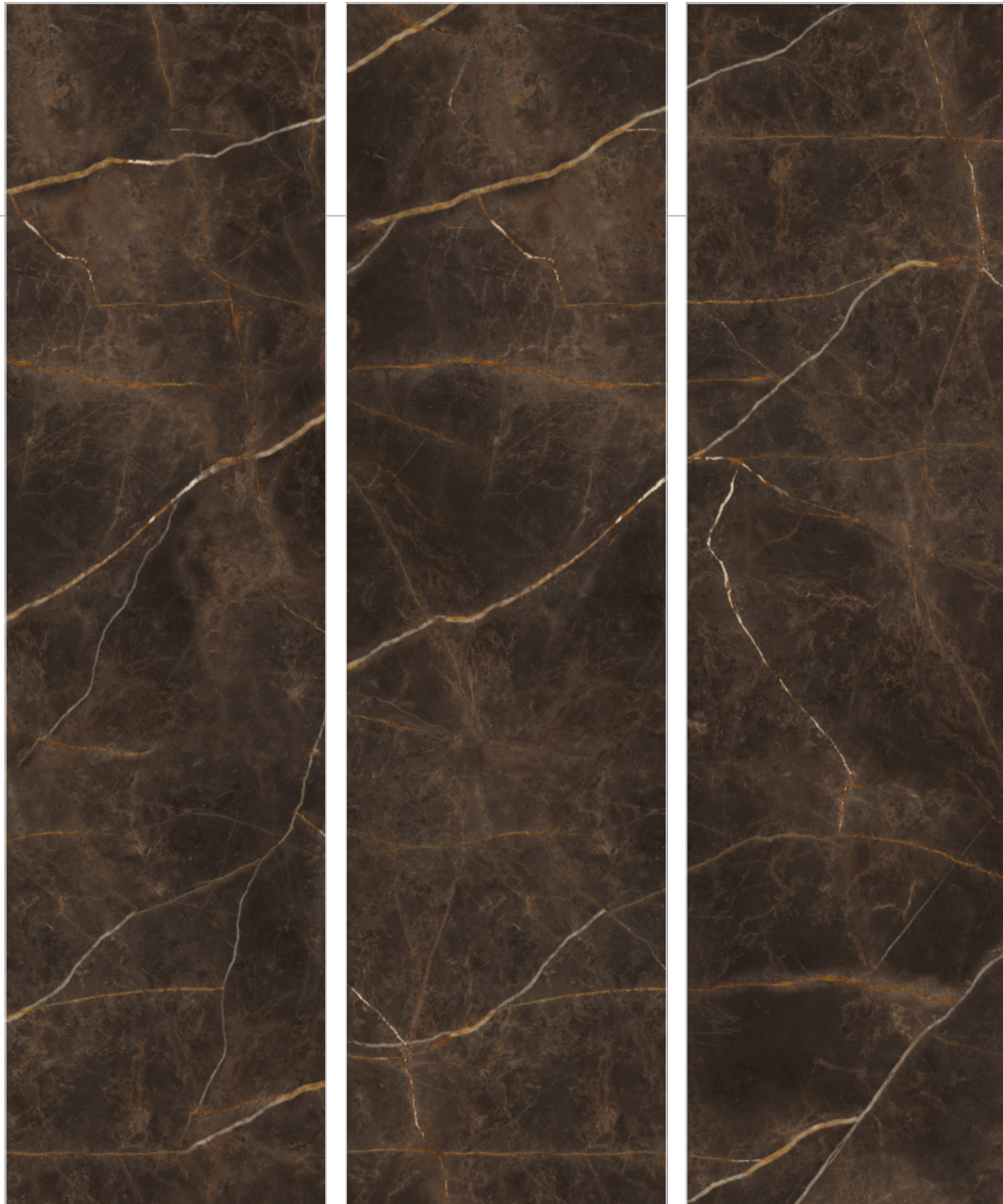

**BROWN
BODY**

ROCK

| ELEGANT BRONZE

FINISH • HIGH GLOSSY
THICKNESS • 15 MM
RANDOM • 3
AVAILABLE SIZES •

80X
240 CM

80X
300 CM

80X
320 CM

 **BACK TO
INDEX**





| EMPERADOR QUARTZ

● BROWN BODY | HIGH GLOSSY | 80X240 CM / 80X300 CM / 80X320 CM

Natural brown layers infused with mineral depth
create a surface that feels calm and enduring.

Designed for environments that speak warmth and stability.

| EMPERADOR QUARTZ

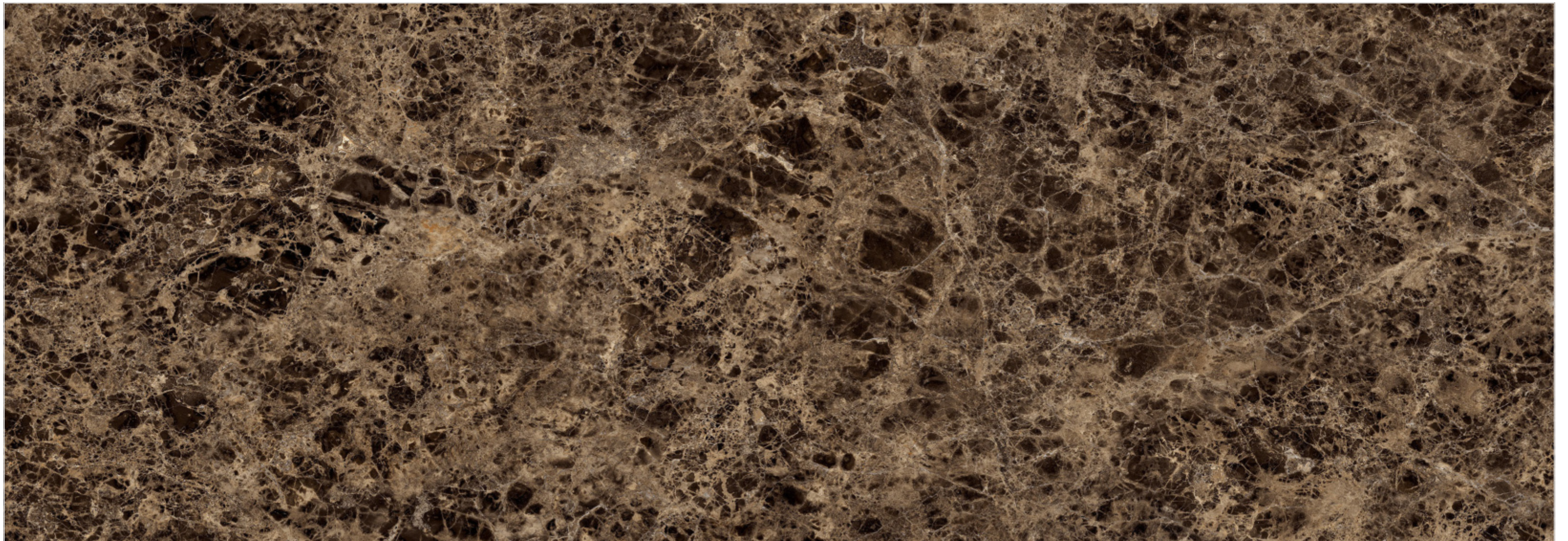

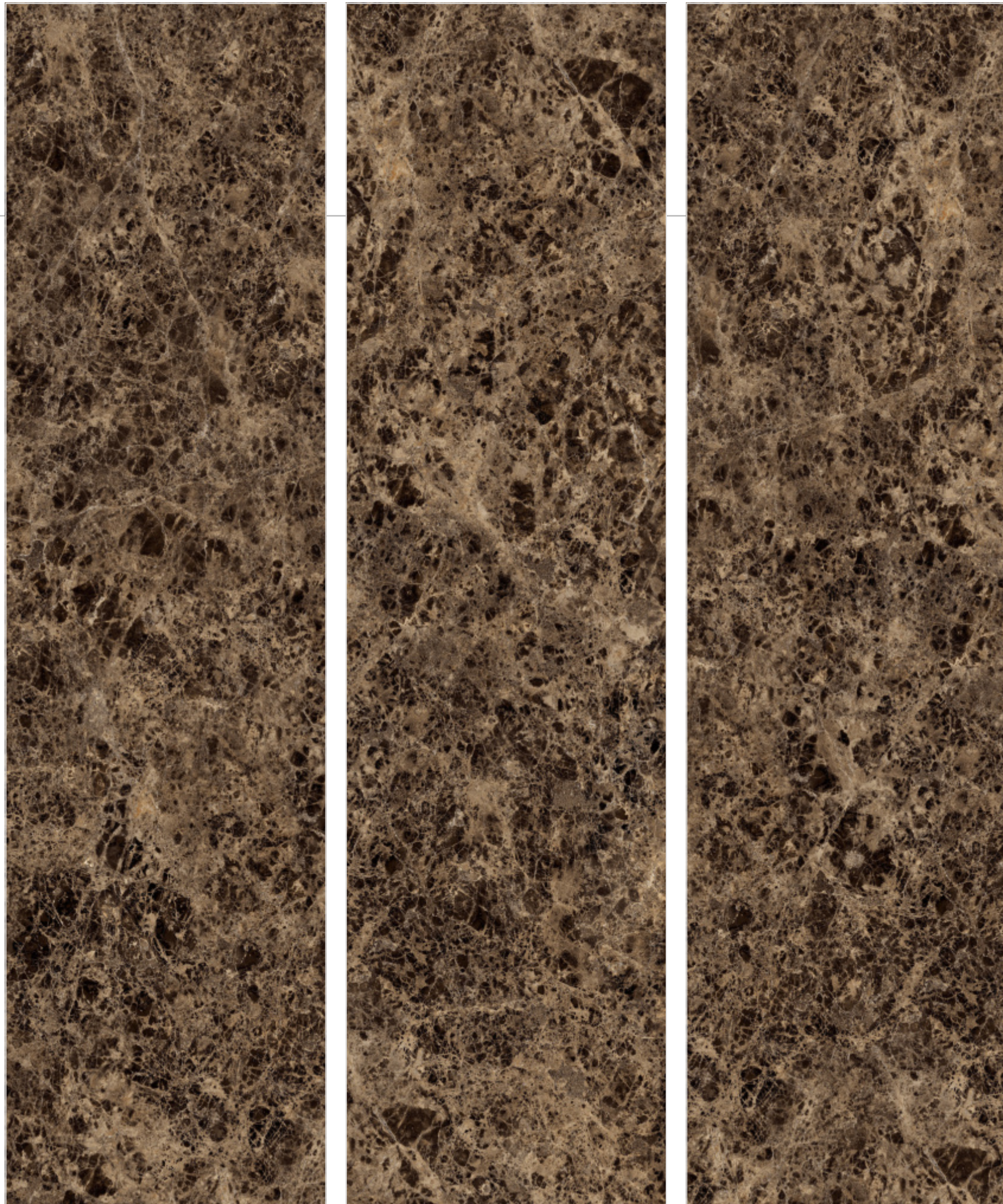

 **BROWN
BODY**

ROCK

| **EMPERADOR QUARTZ**

FINISH • HIGH GLOSSY
THICKNESS • 15 MM
RANDOM • 3
AVAILABLE SIZES •

80X
240 CM

80X
300 CM

80X
320 CM

 **BACK TO
INDEX**





| OLMPIYA

● BROWN BODY

| HIGH GLOSSY

| 80X240 CM / 80X300 CM / 80X320 CM

Earth-toned surfaces refined through natural detailing create
a presence that feels organic and sophisticated.

Made for spaces that celebrate warmth in design.

| OLMPIYA





 **BROWN
BODY**

ROCK

| **OLMPIYA**

FINISH • HIGH GLOSSY
THICKNESS • 15 MM
RANDOM • 3
AVAILABLE SIZES •

80X
240 CM

80X
300 CM

80X
320 CM

 **BACK TO
INDEX**



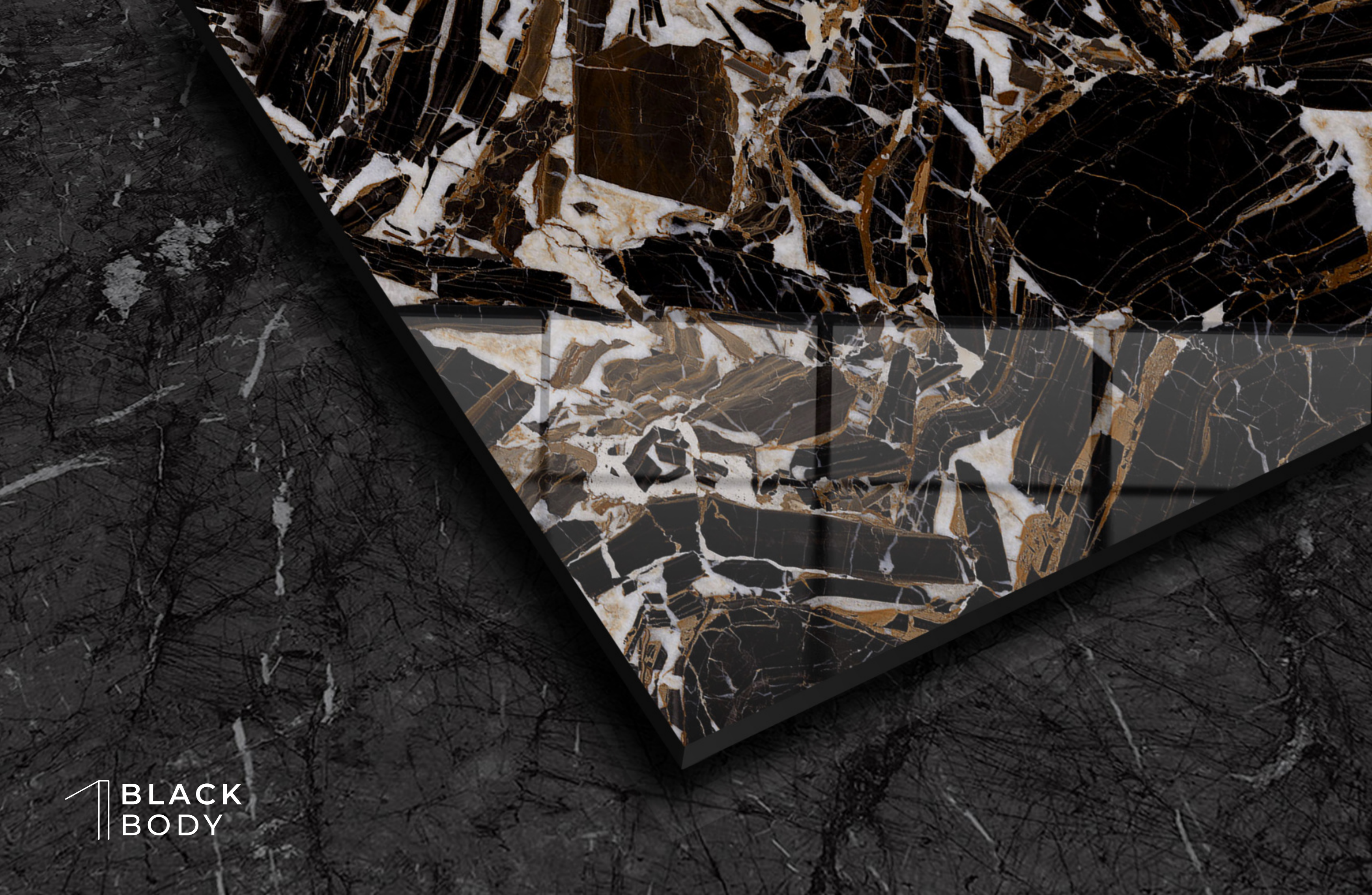

 **BLACK
BODY**



| GRIGIO INTENSO

● BLACK BODY

| HIGH GLOSSY

| 80X240 CM / 80X300 CM / 80X320 CM

Smoky, flowing textures meet delicate lines,
bringing a sense of sophistication and quiet elegance

create spaces that feel distinct and refined

| GRIGIO INTENSO

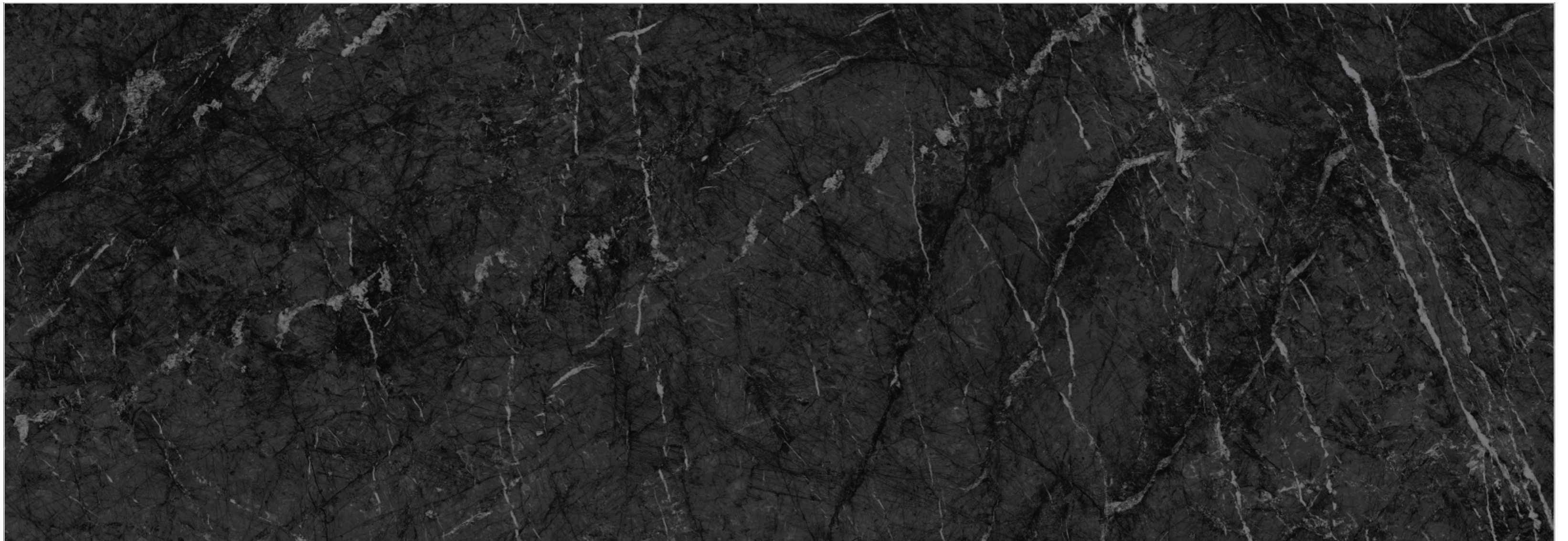



 **BLACK
BODY**

ROCK

| **GRIGIO INTENSO**

FINISH • HIGH GLOSSY
THICKNESS • 15 MM
RANDOM • 3
AVAILABLE SIZES •

80X
240 CM

80X
300 CM

80X
320 CM

 **BACK TO
INDEX**





| LABRADORITE

● BLACK BODY

| HIGH GLOSSY

| 80X240 CM / 80X300 CM / 80X320 CM

Dark mineral tones flowing with subtle veining
create a surface that feels luxurious and distinctive.

Made for environments that reflect confidence and character.

| LABRADORITE

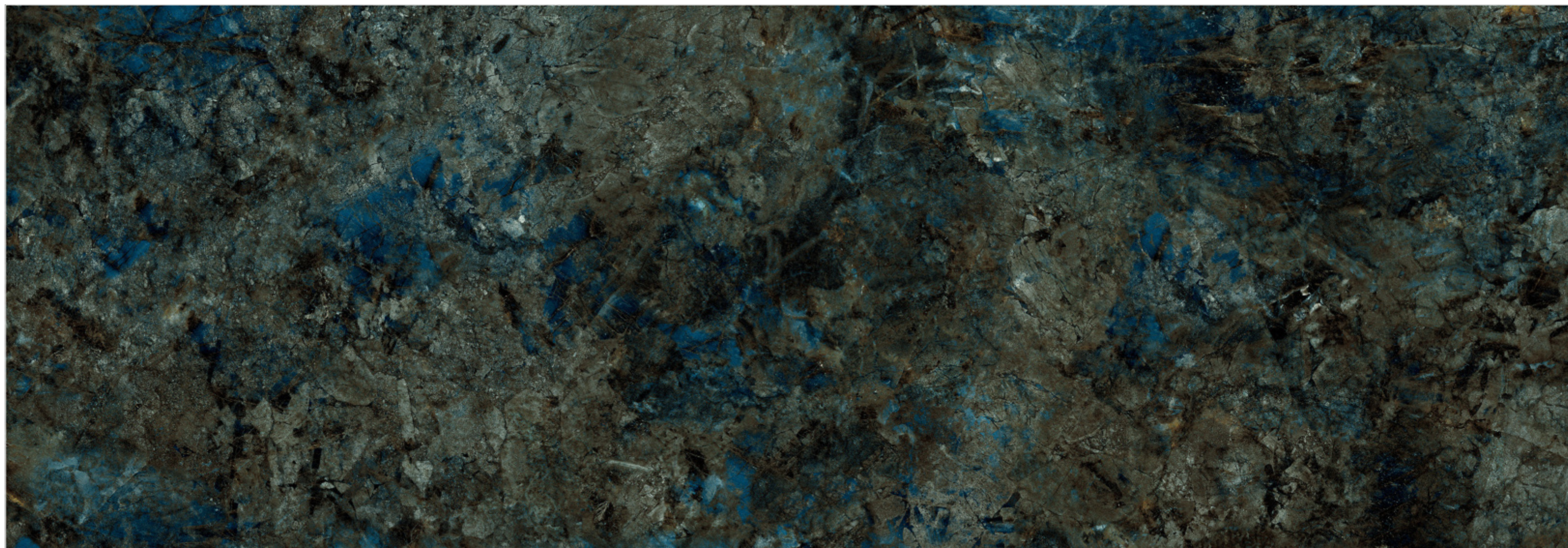

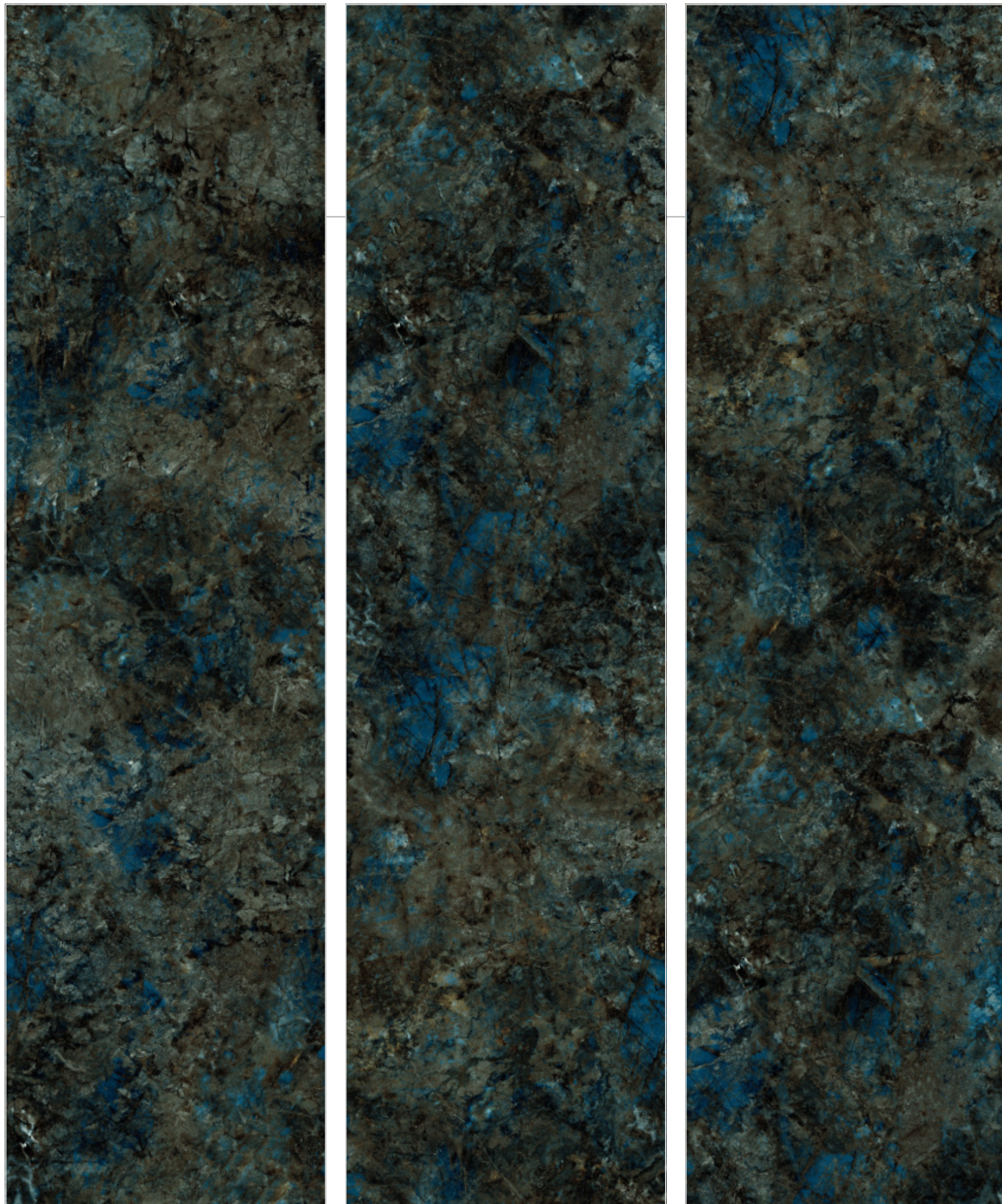

 **BLACK
BODY**

ROCK

| **LABRADORITE**

FINISH • HIGH GLOSSY
THICKNESS • 15 MM
RANDOM • 3
AVAILABLE SIZES •

80X
240 CM

80X
300 CM

80X
320 CM

 **BACK TO
INDEX**





| MARQUINA NERO

● BLACK BODY | HIGH GLOSSY | 80X240 CM / 80X300 CM / 80X320 CM

Rich stone hues ripple with restrained movement,
offering surfaces that balance bold presence

Perfect for that define modern prestige.

| MARQUINA NERO

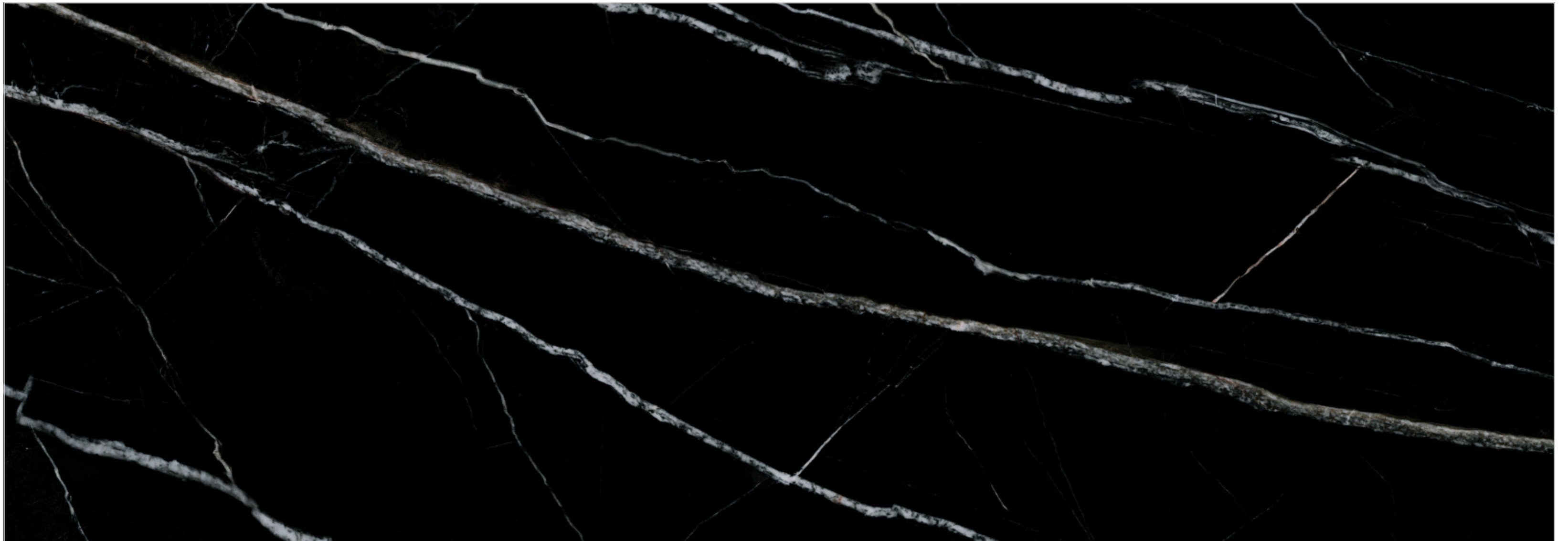

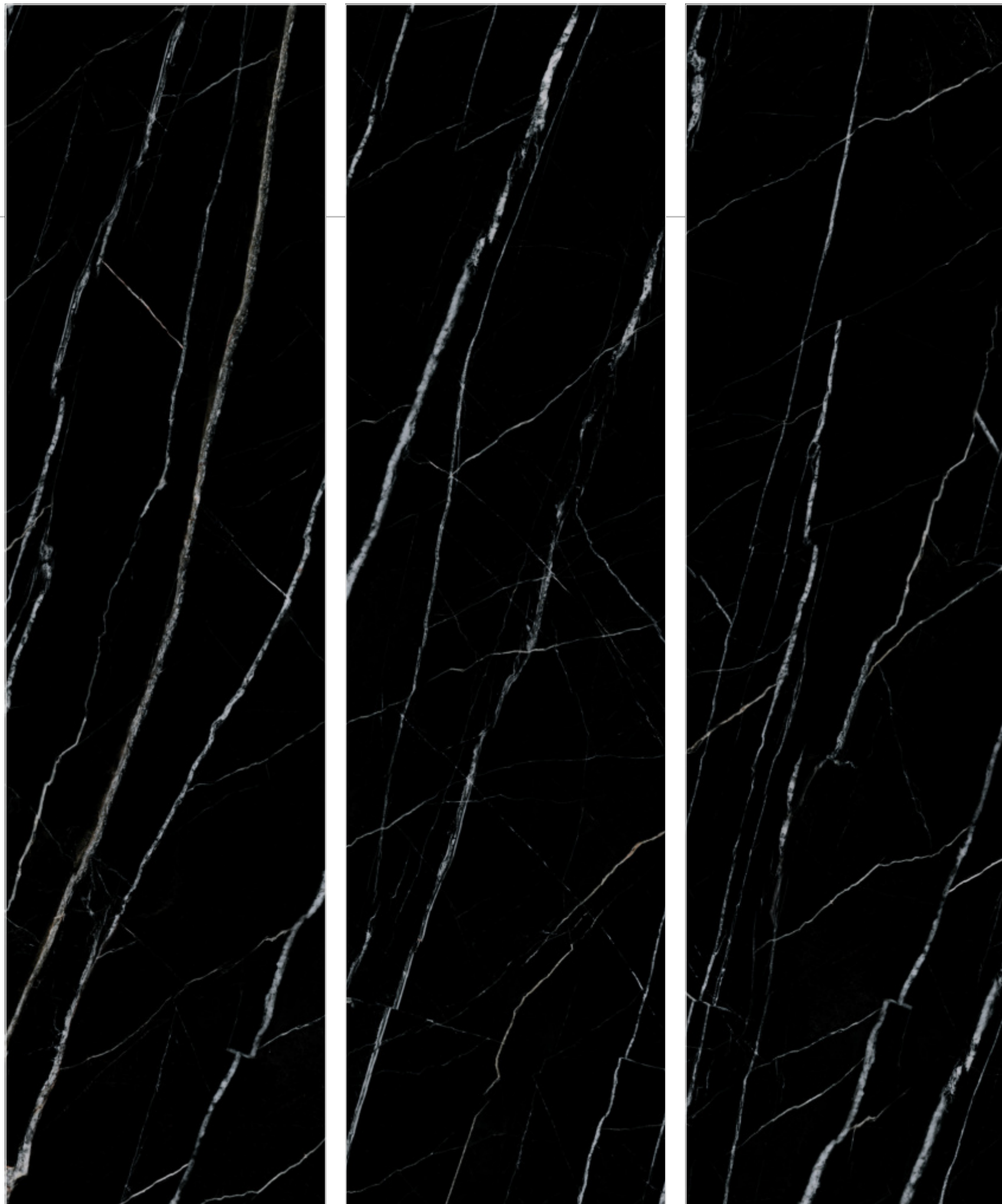

 **BLACK
BODY**

ROCK

| **MARQUINA NERO**

FINISH • HIGH GLOSSY
THICKNESS • 15 MM
RANDOM • 3
AVAILABLE SIZES •

80X
240 CM

80X
300 CM

80X
320 CM

 **BACK TO
INDEX**





| NOIR BLACK

● BLACK BODY

| HIGH GLOSSY

| 80X240 CM / 80X300 CM / 80X320 CM

Rich black depths infused with gentle veins create
a surface that feels commanding and serene.

Designed for spaces where confidence meets calm luxury.

| NOIR BLACK



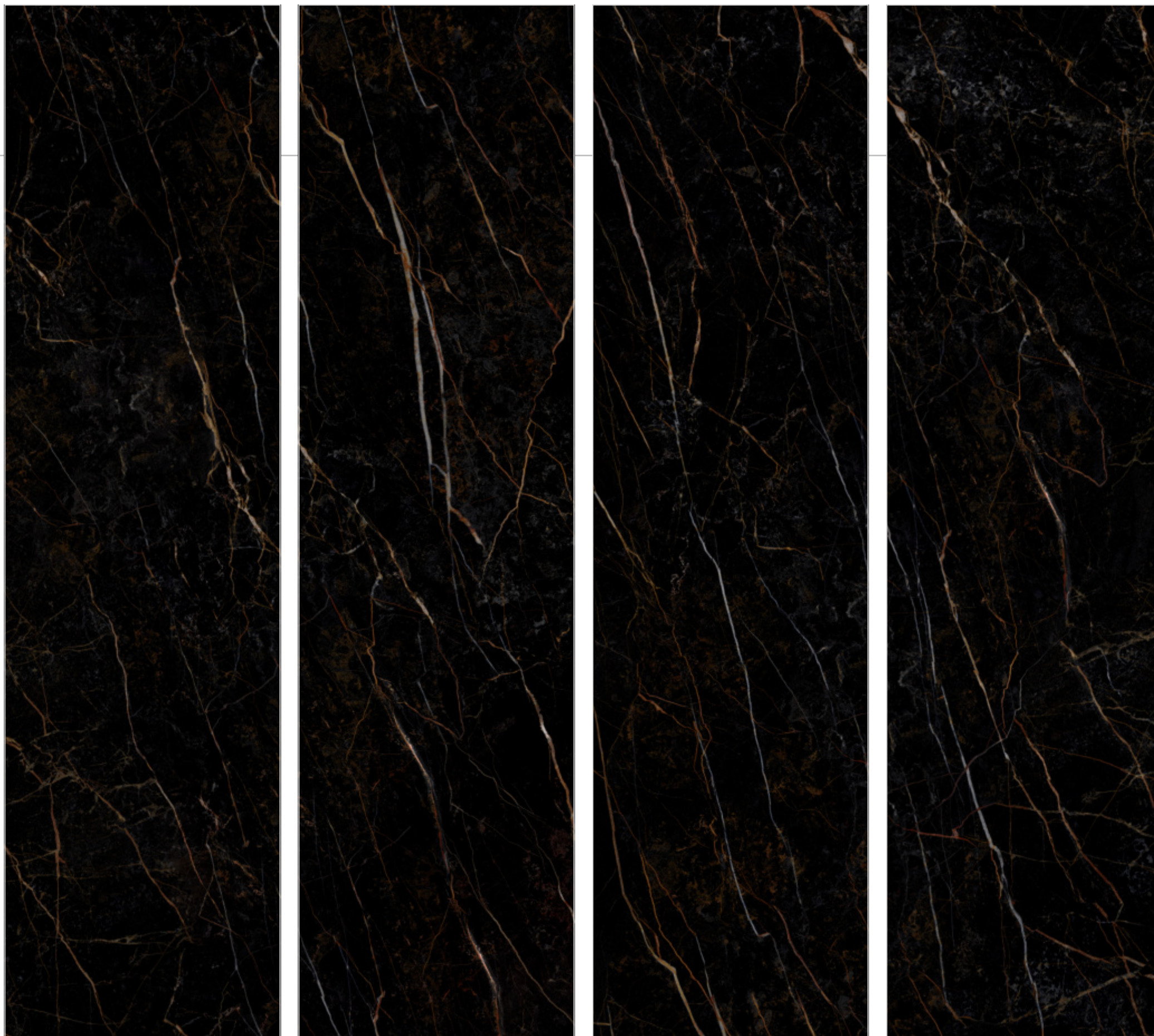

 **BLACK
BODY**

ROCK

| **NOIR BLACK**

FINISH • HIGH GLOSSY
THICKNESS • 15 MM
RANDOM • 4
AVAILABLE SIZES •

80X
240 CM

80X
300 CM

80X
320 CM

 **BACK TO
INDEX**





| PRISMA NOIR

● BLACK BODY

| HIGH GLOSSY

| 80X240 CM / 80X300 CM / 80X320 CM

Deep obsidian tones accented with organic textures create a surface that feels premium and bold.

For leave a lasting impression of power and style.

| PRISMA NOIR





 **BLACK
BODY**

ROCK

| **PRISMA NOIR**

FINISH • HIGH GLOSSY
THICKNESS • 15 MM
RANDOM • 3
AVAILABLE SIZES •

80X
240 CM

80X
300 CM

80X
320 CM

 **BACK TO
INDEX**





| SAINT LAURENT

● BLACK BODY | HIGH GLOSSY | 80X240 CM / 80X300 CM / 80X320 CM

Deep black layers enriched with natural veining create
a surface that feels bold, immersive, and refined.

Designed for embody confidence and modern elegance.

| SAINT LAURENT

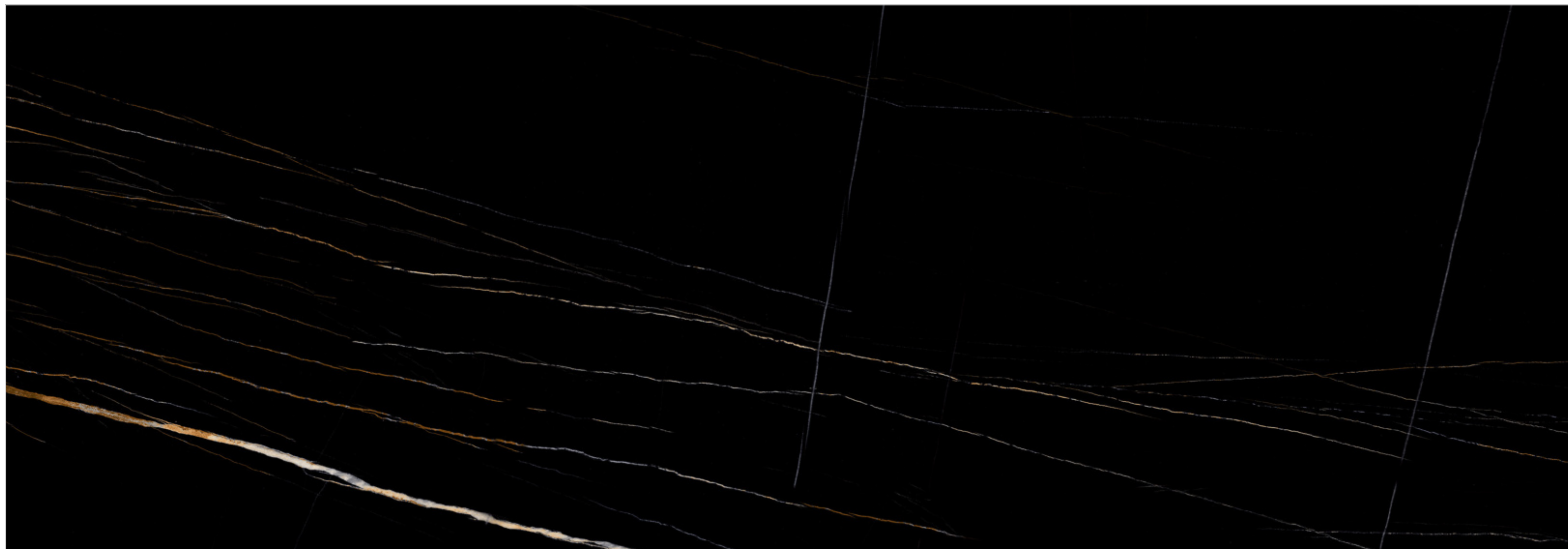

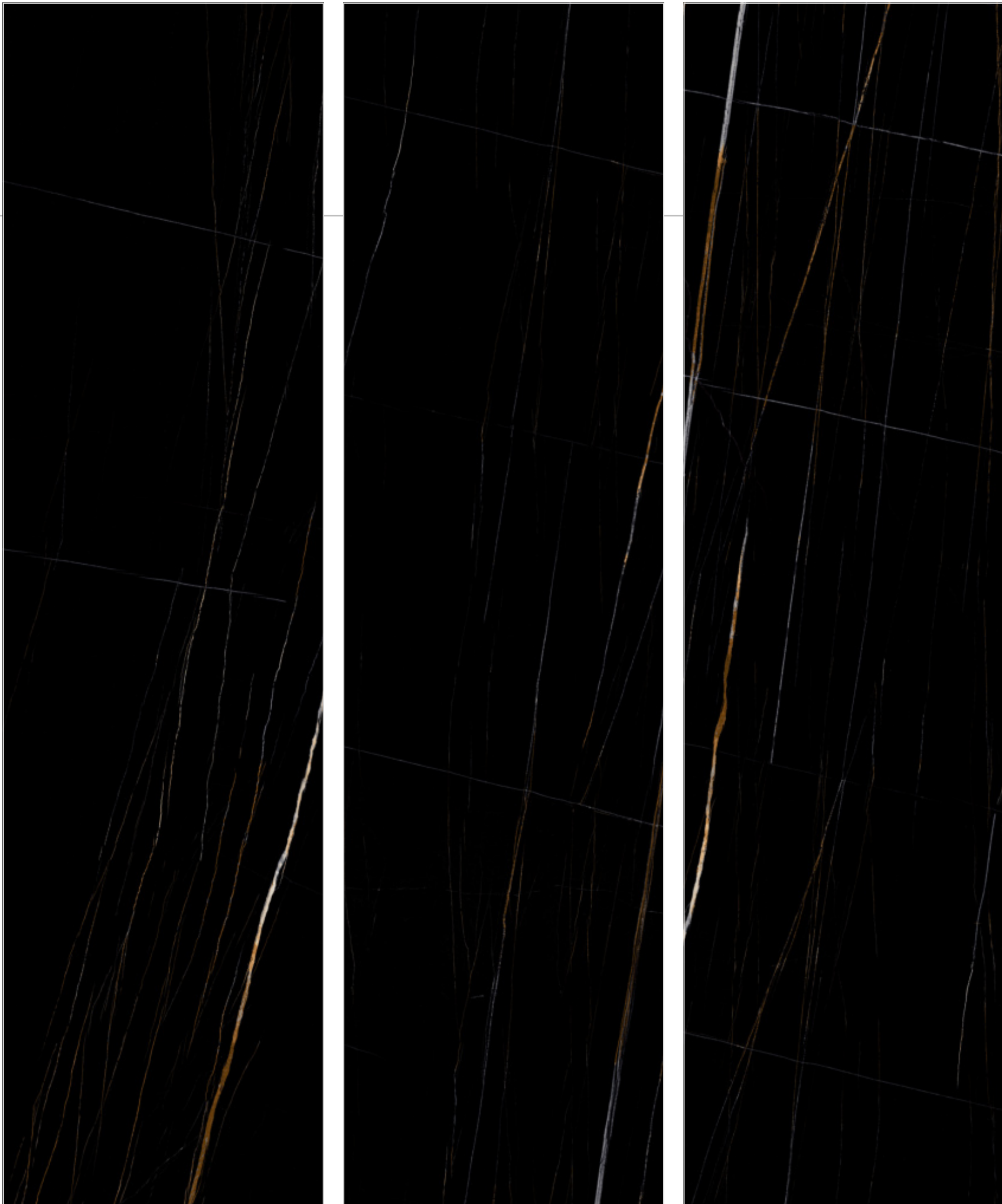

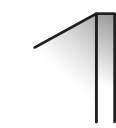
 **BLACK
BODY**

ROCK

| **SAINT LAURENT**

FINISH • HIGH GLOSSY
THICKNESS • 15 MM
RANDOM • 3
AVAILABLE SIZES •

80X
240 CM

80X
300 CM

80X
320 CM

 **BACK TO
INDEX**





| VEINS BLACK

● BLACK BODY

| HIGH GLOSSY

| 80X240 CM / 80X300 CM / 80X320 CM

Dark tonal depths shaped by organic patterns
create a surface that feels powerful yet beautifully balanced.

Crafted for spaces that reflect authority with sophistication.

| VEINS BLACK

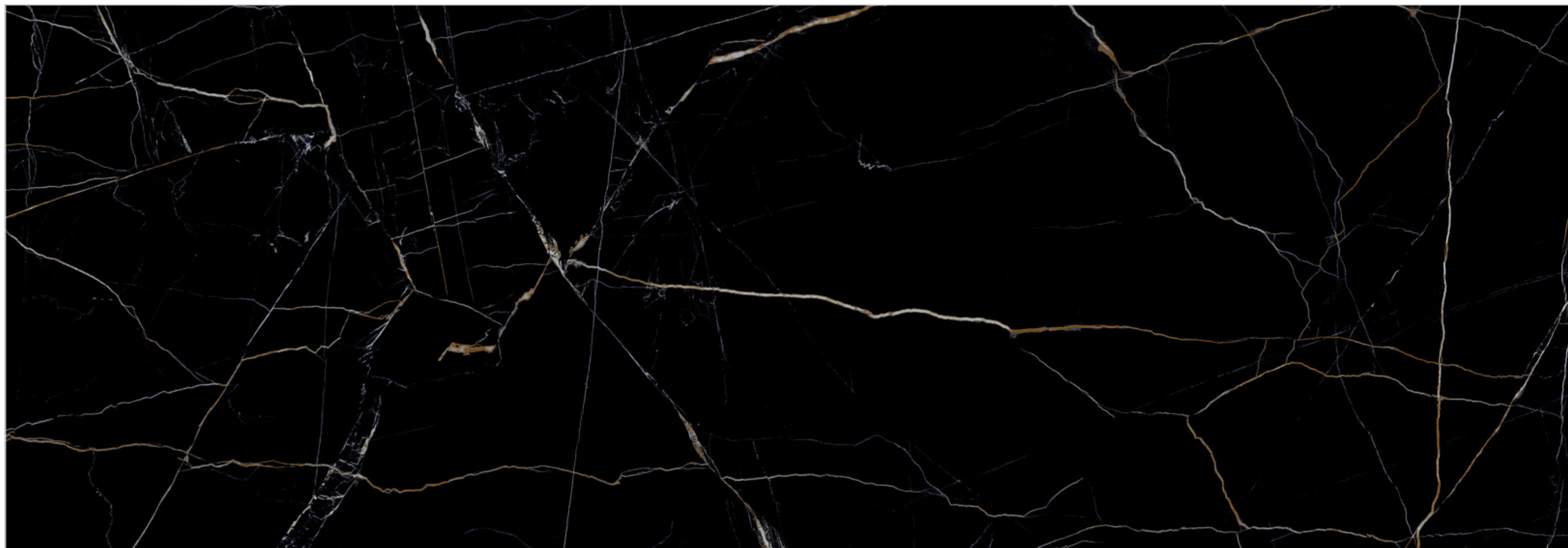

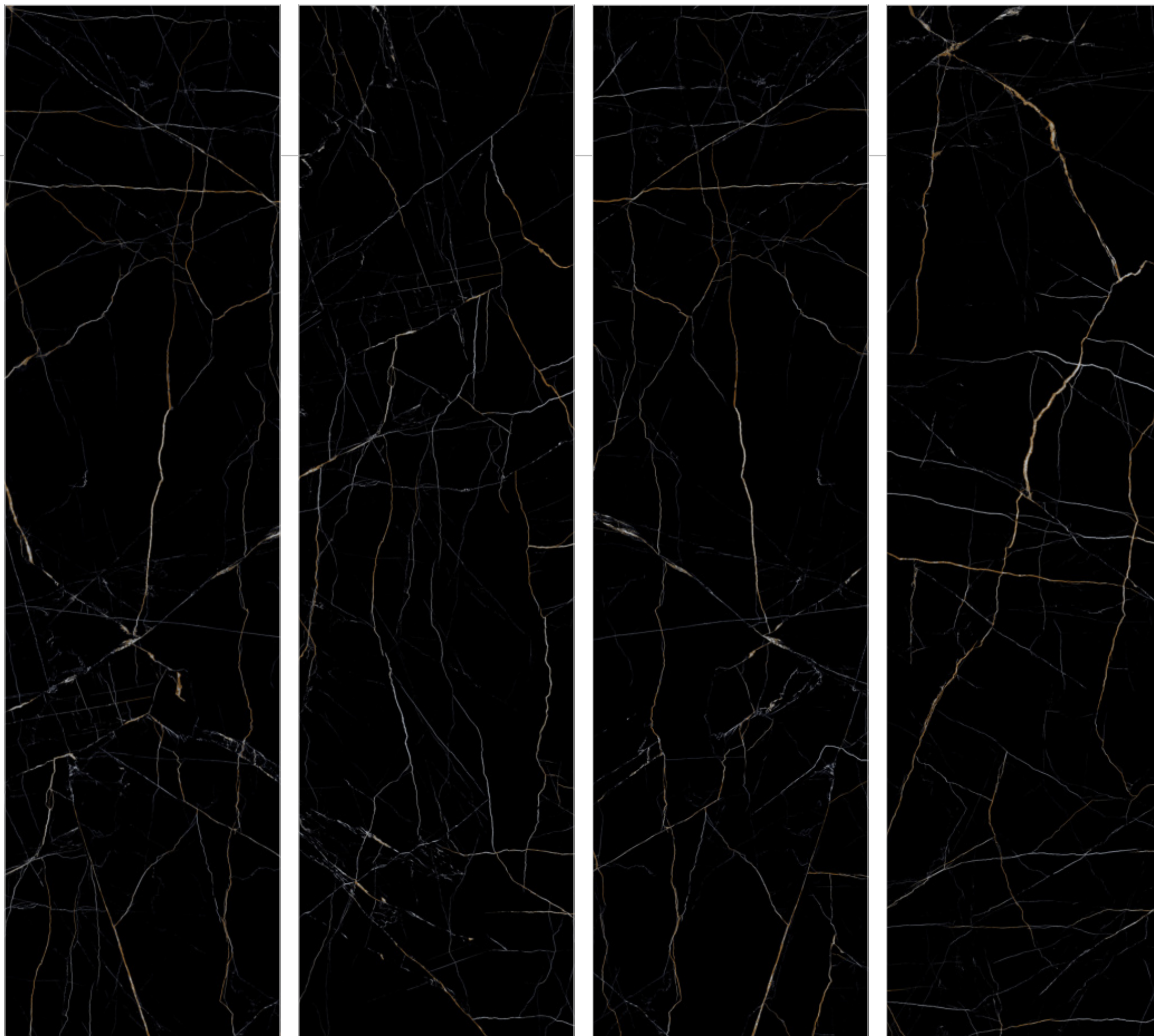

 **BLACK
BODY**

ROCK

| **VEINS BLACK**

FINISH • HIGH GLOSSY

THICKNESS • 15 MM

RANDOM • 4

AVAILABLE SIZES •

80X
240 CM

80X
300 CM

80X
320 CM

 **BACK TO
INDEX**





| VOLGA BLUE

● BLACK BODY

| HIGH GLOSSY

| 80X240 CM / 80X300 CM / 80X320 CM

Natural minerals in deep, expressive tones
carry subtle patterns that hint at depth and elegance,

Making every surface a statement of distinction.

| VOLGA BLUE

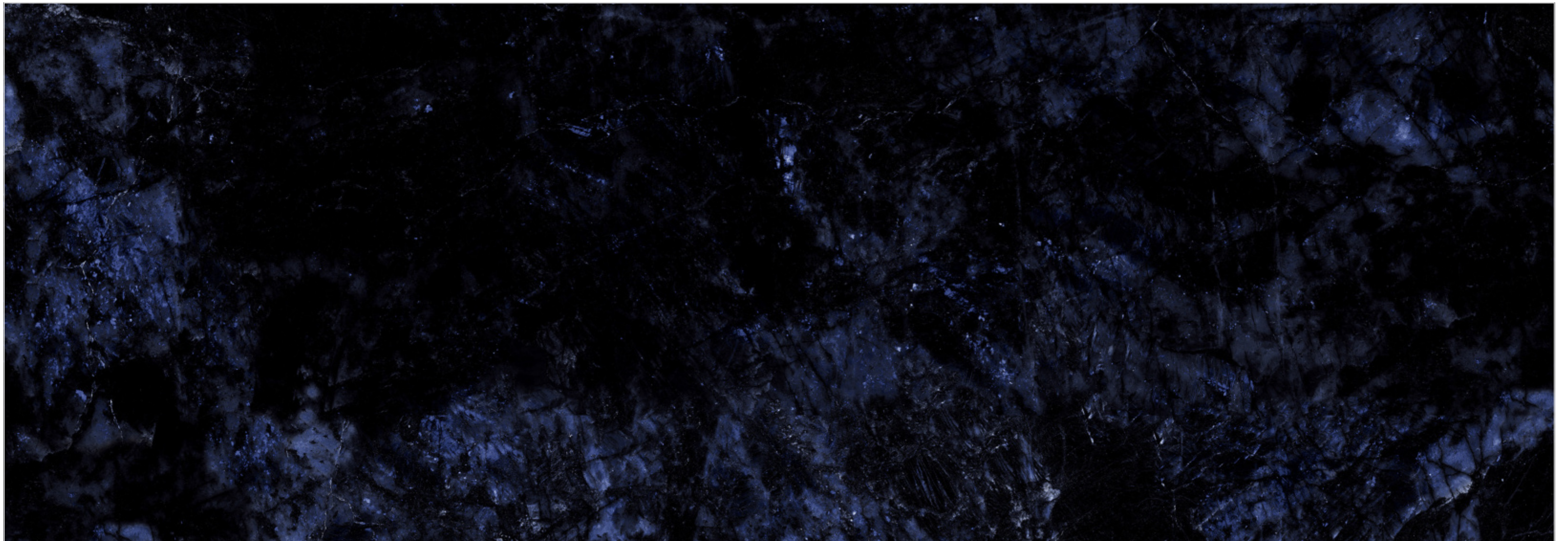

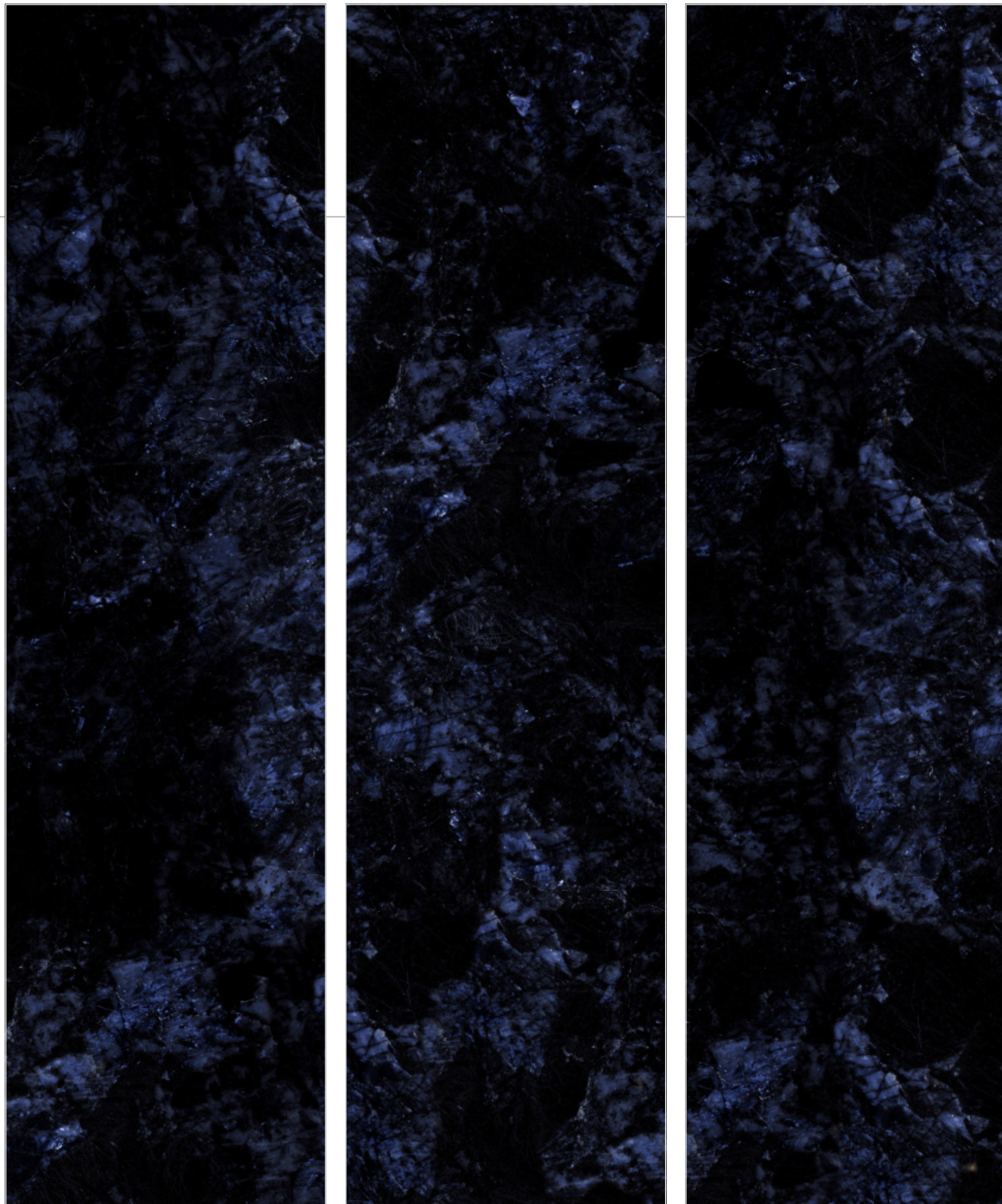

 **BLACK
BODY**

ROCK

| **VOLGA BLUE**

FINISH • HIGH GLOSSY
THICKNESS • 15 MM
RANDOM • 3
AVAILABLE SIZES •

80X
240 CM

80X
300 CM

80X
320 CM

 **BACK TO
INDEX**





| VORTEX BROWN

● BLACK BODY

| HIGH GLOSSY

| 80X240 CM / 80X300 CM / 80X320 CM

Obsidian tones guided by nature's lines
create a surface that feels artistic and powerful.

Made for spaces that define bold contemporary living.

| VORTEX BROWN

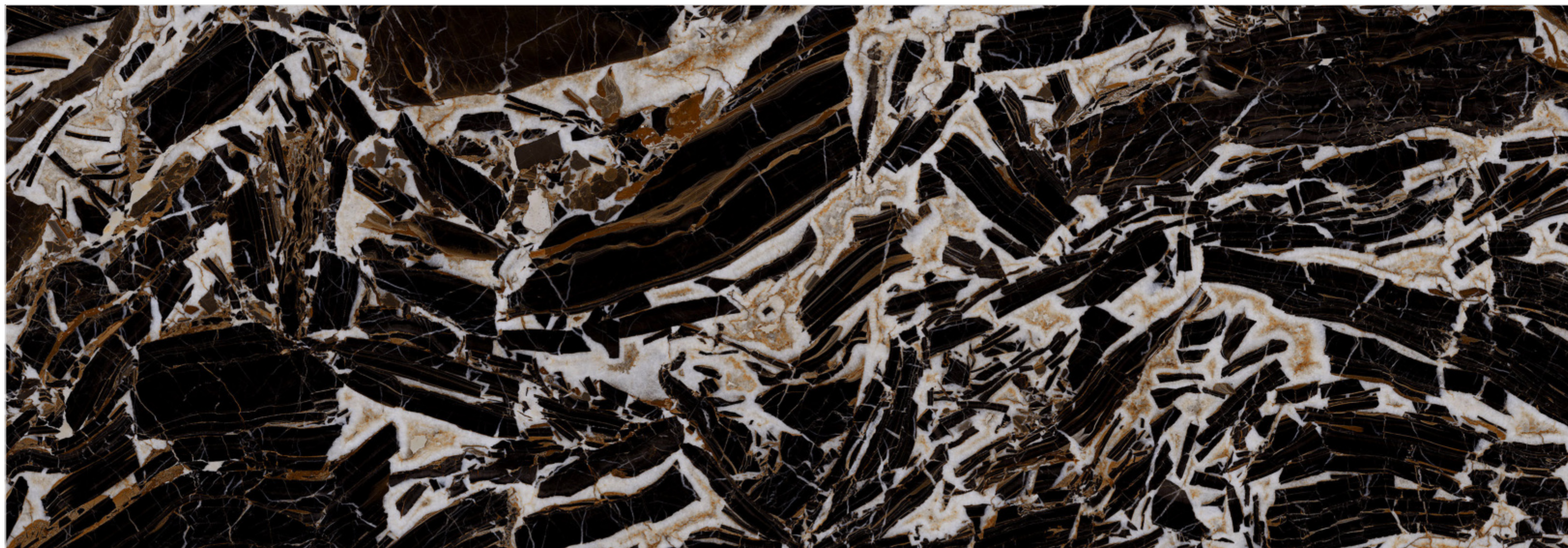

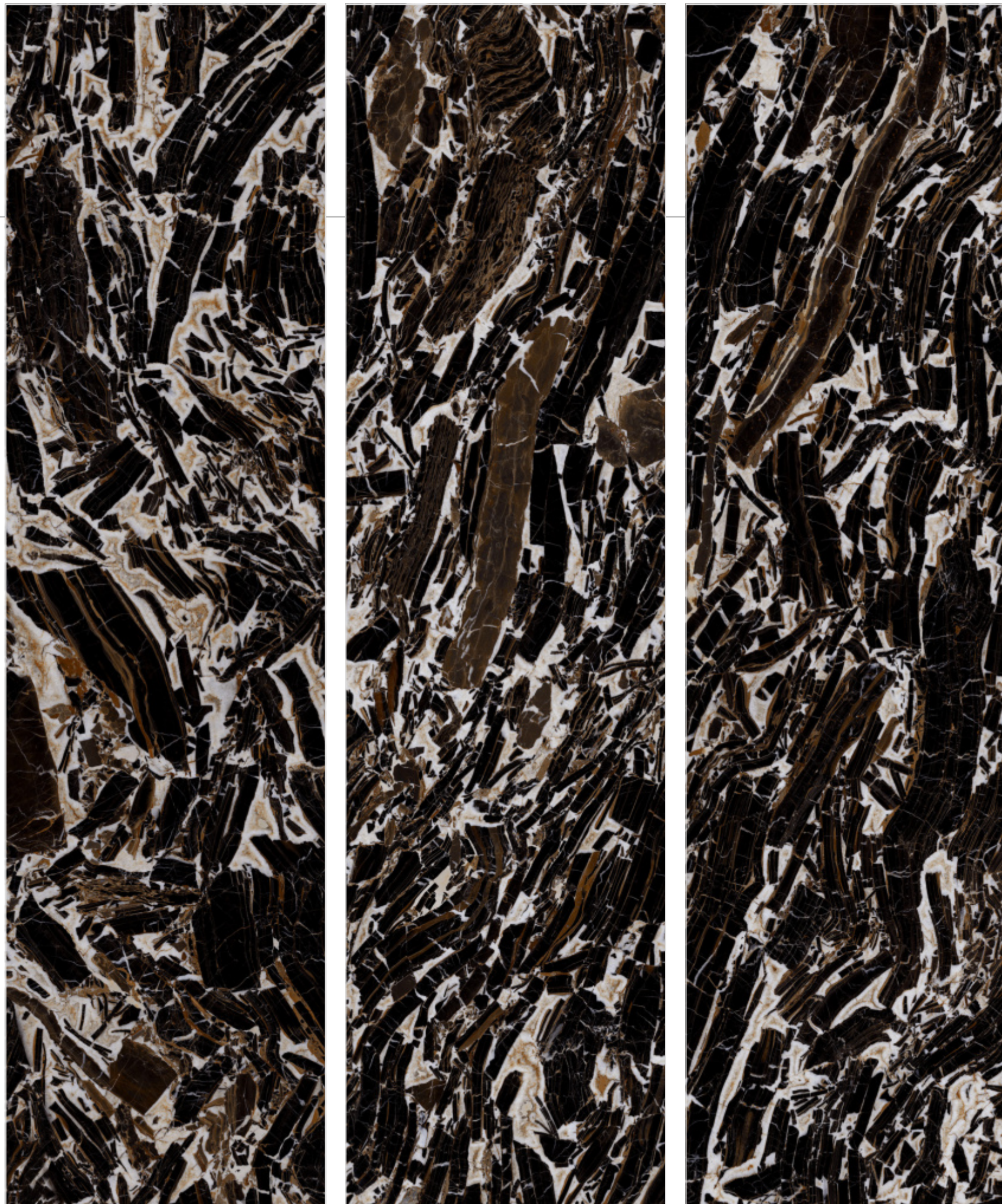

 **BLACK
BODY**

ROCK

| **VORTEX BROWN**

FINISH • HIGH GLOSSY
THICKNESS • 15 MM
RANDOM • 3
AVAILABLE SIZES •

80X
240 CM

80X
300 CM

80X
320 CM

 **BACK TO
INDEX**







| ONYX GREEN

● GREEN BODY

| HIGH GLOSSY

| 80X240 CM / 80X300 CM / 80X320 CM

Rich emerald hues shaped by subtle veining
create a surface that feels refreshing and refined.

Perfect for spaces that express harmony with confidence.

| ONYX GREEN

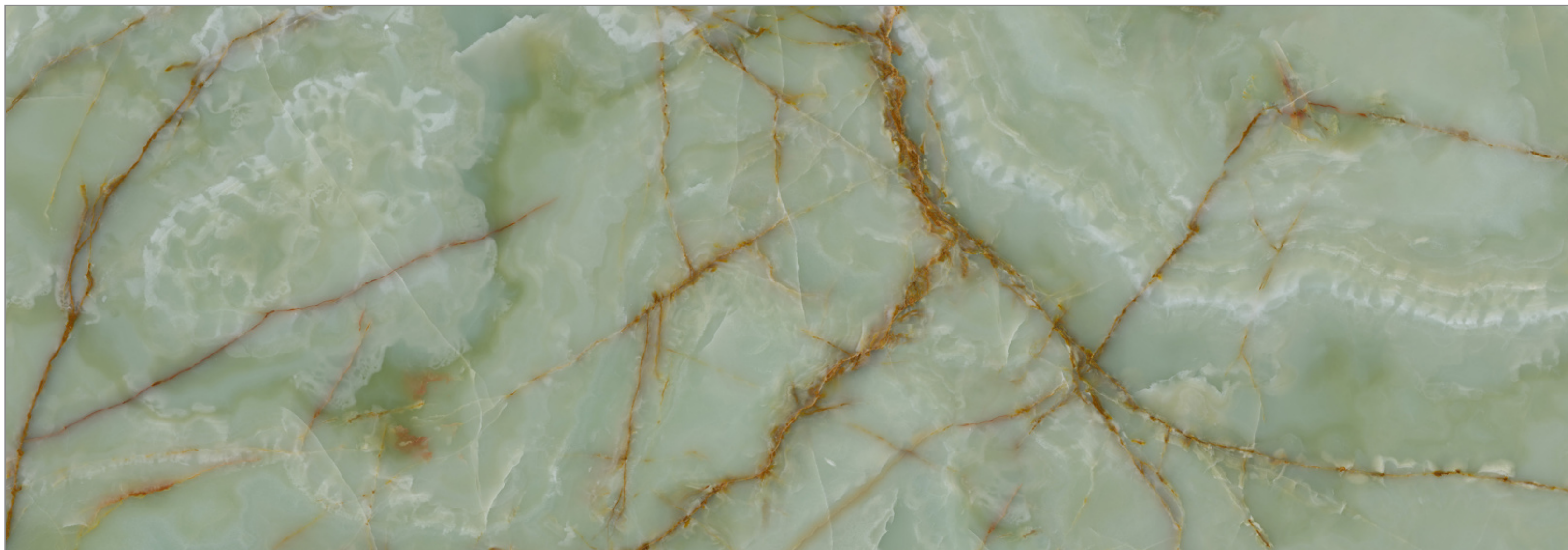

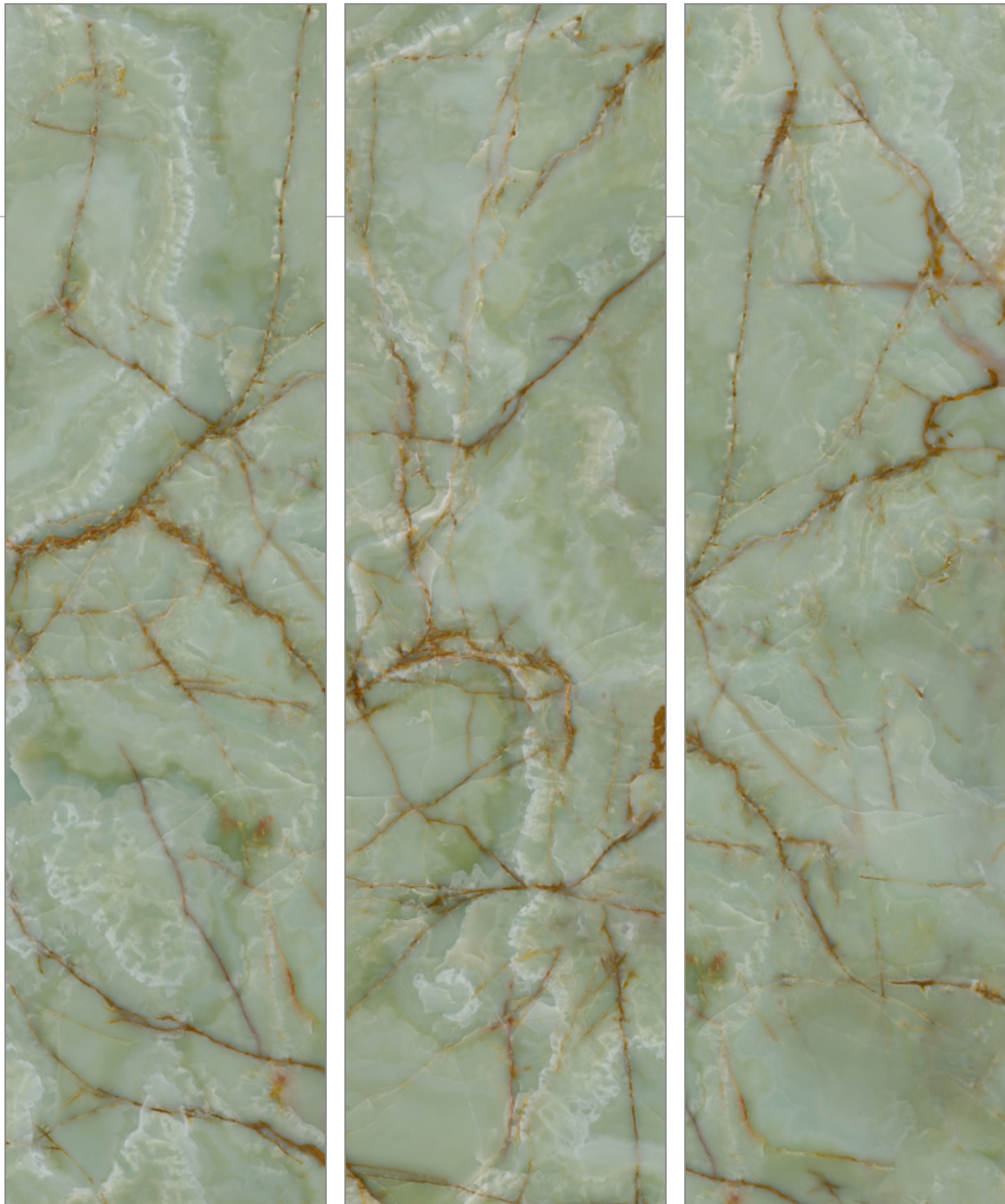

 **GREEN
BODY**

ROCK

| **ONYX GREEN**

FINISH • HIGH GLOSSY
THICKNESS • 15 MM
RANDOM • 3
AVAILABLE SIZES •

80X
240 CM

80X
300 CM

80X
320 CM

 **BACK TO
INDEX**



Technical information

General information

This slabs in sizes 80x320 cm (15 mm thick), 80x300 cm (15 mm thick) & 80x240 cm (15 mm thick) are made of porcelain stoneware that is rectified and wedged and has a single size grade. As far as technical performance is concerned, they are manufactured in compliance with the EN ISO 14411 ISO 13006 Annex G standards for group B1A material.

Packaging

Rock slabs are not boxed but rather arranged loose inside crates or on trestles, according to the data given in the table on. Only crates can be used for the 80x320cm size slab. For more details, please refer to the Technical Manual.

Transport and unloading

During transport, Caesar recommends you not to stack other types of pallet onto the cases containing these products. It is also recommended to use elevator and forklift trucks of dimensions that are suitable for handling the above mentioned pallets. As far as cases containing 80x320 cm are concerned, if you are lifting the case from its short side, it is recommended to use forks with a length of 2400 mm. For cases containing 80x240 cm slabs, it is recommended to widen the forks as far as is possible in order guarantee effective support of the case: if you are lifting the case from its short side, it is recommended to use forks with a length of at least 2800 mm.

Checking material

Fitters must always check material before installation, by placing a few slabs on the floor and making sure that they correspond to specifications both technical and aesthetic. Fitters should also ensure that the slabs are in good condition; please remember than any complaints relating to visible faults on slabs that have been installed will not be taken into consideration.

Handling slabs at the work site

Rock slabs have considerable dimensions and weight. This means that some precautions must be taken to guarantee safe work and avoid breakage of the slabs. For handling and subsequent installation, Caesar recommends the use of suitable equipment, namely a special handling frame, featuring suction cups for lifting the slabs, and, if necessary, a trolley with wheels for transporting heavy weights (approx. 83 kg plus the weight of the adhesive for 80x320 slabs). It is recommended to pay particular attention during movement of each single slab: owing to the considerable dimensions, be particularly careful in order to prevent breakage caused by collision or excessive bending. In particular, for sizes 80x320 and 80x240, it takes at least four qualified operators to take the slab out of the case and move it in the work site area. All operations must be performed in compliance with the local standards for health and safety at work, in particular those relating to handling of heavy weights and particularly troublesome sizes; the use of a frame with telescopic arms facilitates extraction of the slabs at the bottom of the case.

Cutting and drilling

To cut and drill a slab, Rock recommends you to place the slab on a work bench or flat surface made of non-slip material.

- Straight cuts: Rock slabs of sizes 80x320 cm, 80x240 cm can be cut using a cutting guide with engraving trolley featuring suction cups, cutting-off pliers and a diamond pad. Place the slab on the cutting guide, establish the contour of the portion to remove and trace it out, making sure to lock the cutting guide in place using the special suction cups it is fitted with. During engraving, it is recommended to start with two engravings of about 5 cm, at the two ends of the slab. Proceed moving from the inside to the outside; you can then complete engraving by joining these two segments. Now perform splitting using pliers. Make sure to begin your work starting from the two ends. It is then recommended to smooth the cut edge using a diamond pad. In the event of straight cuts close to the edge, it is possible to use an angle grinder, which must be appropriately secured to the guide.
- Corner cutting: corner cutting can be performed in the same manner described for straight cuts close to the edge. Make sure to position the angle grinder based on the corner cut to perform.
- L-shaped cuts: for this type of work, use an angle grinder with a diamond disc and a diamond tool for wet drilling. Start by drilling a hole with a diameter of 7/8 mm, near to the portion to remove. Continue your work using the angle grinder. Provide two engravings of about 5 cm at the two ends of the same portion. Complete by joining the hole to the engraving. Work moving from the centre to the end.
- Rectangular holes: as described for L-shaped cuts, the tools needed are an angle grinder with diamond disk and a diamond tool for wet drilling. Before cutting, use the diamond tool to drill holes with a diameter of 7/8 mm in the points at the ends of the cutting area. You can complete your work by joining the holes using the angle grinder with diamond disc.
- Holes: you can drill material by using a screwdriver and diamond tools for wet drilling (cutting discs). During drilling, make sure that the area involved in kept wet. Once the hole has been completed, finish off the surface with an angle grinder with diamond disc.

List of equipment for handling, cutting and drilling:

- frame for handling featuring suction cups for lifting the slab and, if necessary, trolley for transport;
- work bench of a suitable size;
- cutting guide with engraving trolley;
- cutting off pliers;
- diamond pad;
- angle grinder with diamond disc;
- diamond tool for wet drilling (cutting disc);
- screwdriver.

Recommendations for installation on a screed for wall tiling (all types of slab)

As reference, we recommend you to consult the UNI 11493 standard that sets forth the rules for installation of interior and exterior floor and wall coverings.

Before beginning installation, check that the substrate for installation has been prepared and built in compliance with the intended use and has been correctly prepared for the use of adhesive.

If the case of cement-based screeds, for floor and wall installation, check that the substrate features no cracks, that it is perfectly dry and that hygrometric shrinkage has ended. Make sure that there is no damp or water seepage that could cause the slabs to dislodge. Clean the surface to remove dust, dirt, oil and grease. Before installation, check the flatness of the substrate and compensate for any hollows with suitable levelling products.

Use category "C2 E" or superior adhesives, as envisaged by the EN 12004 standards; for wall tiling, use products with limited vertical slippage (identified by the letter T or in compliance with the EN 12004 standard).

Adhesive must be applied with the double spreading technique, in order to ensure correct distribution of the adhesive itself, guarantee excellent adhesion and avoid air gaps that can lead to breakage. The adhesive must be spread full-bed on the supporting surface, using a notched trowel (10 mm gap between notches). Make sure that the stripes of the last layer of adhesive have a single direction, parallel to the short side of the slab. The application of adhesive on the rear side of the slab must be performed using a notch with 3 mm notches. The slab must be secured in upright position to the handling frame. Using the frame, you can thus correctly position the slab and install it accordingly. To eliminate any air and guarantee better adhesion, when installing make the slab performs a circular movement.

After installation, it is recommended to tap the surface with a special mallet. Proceed from the centre to the sides, parallel to the short side, to ensure effective elimination of air. Consider the use of levelling systems to improve flatness of the surfaces. In order to improve aesthetic performance and practicality, Caesar recommends a grouting joint of at least 2 mm and use of spacer crosses. The grain size of the jointing material must be suitable for the width of the joint. Joints must be filled up to treading level in order to create a continuous surface. Position expansion joints at a regular distance and leave a gap of at least 5 mm between tiled surface and walls (or pillars). In any case, provision of expansion joints must be calculated by the person in charge of the building site.

All notes above are a necessary addition to the rules of the trade.

Installation of 15 mm thick slabs

Rock recommends the installation of 15 mm thick extra large slabs only in the following conditions: residential environments, commercial environments that are subject to light traffic and in any case in contexts where there is no regular passage of heavy loads or circulation of trolleys with hard wheels. The range of 15 mm thick extra large slabs is suitable for installation on existing floors: the slabs can be installed on old floors or marble, natural stone and ceramic claddings, without the need to demolish the existing underlying floor. **ATTENTION:** it is not recommended to install these slabs on a screed directly, since the results of installation strictly relate to the condition - excellent - of the screed, to its seasoning, to the provision of expansion joints, as well as to perfect installation in accordance to "the rules of the trade". In these cases, Rock recommends the use of porcelain stoneware with a conventional thickness.

Care and cleaning

In order to make routine maintenance easier, it is recommend to wash the surface with an acid detergent 36-48 hours from grouting. Use an acid product that is suitable for porcelain stoneware. For more information, visit the www.rockgranito.com website.

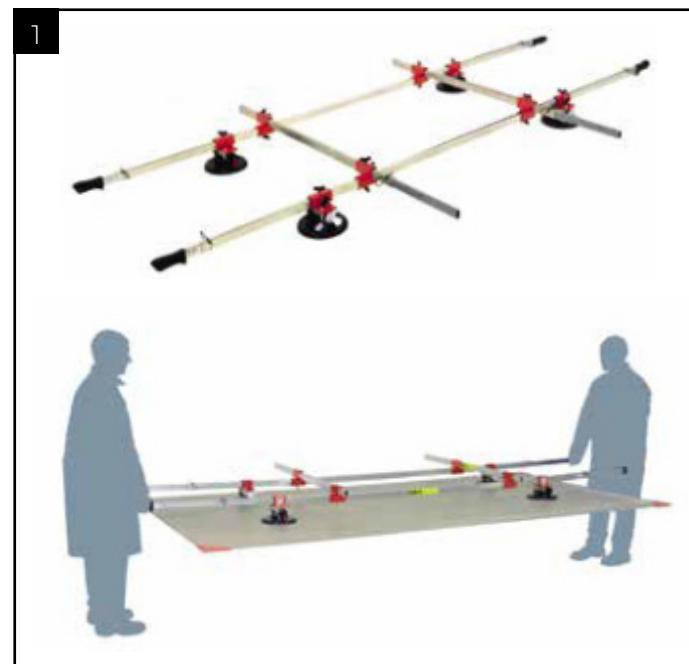

1. Handling frame equipped with suction cups



2. Wheeled trolley for transport



3. Working table

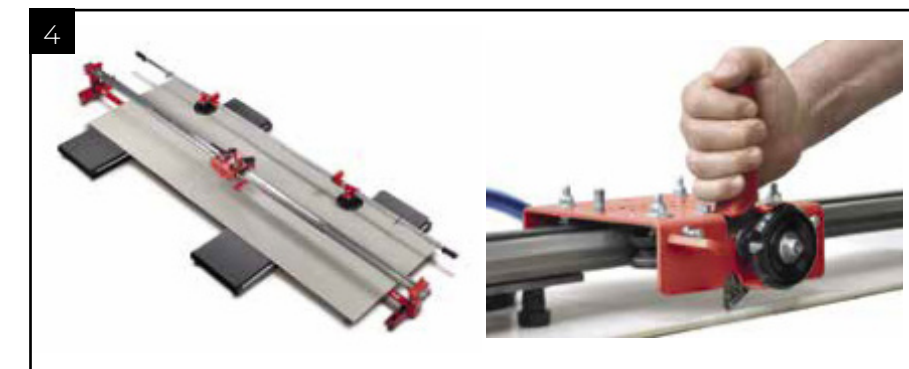

4. Guide with cutting carriage



5. Diamond tool for wet drilling

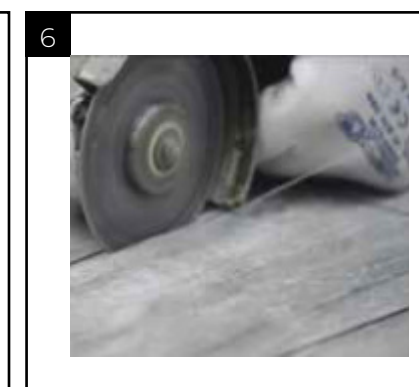

6. Grinder equipped with diamond disk

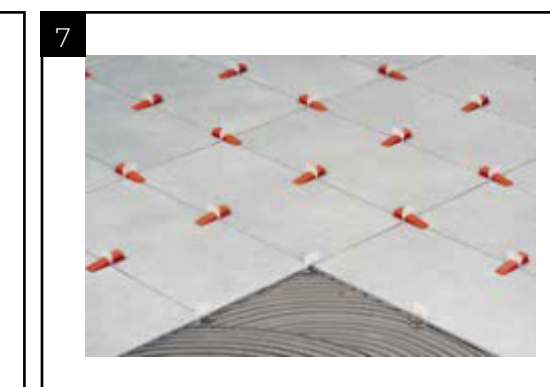

7. Surface levelling systems



CLEANING & MAINTENANCE

Our products are non porous (due to their high quality raw materials, stringent production parameters and state of the art technology), hence any dust or deposited waste cannot penetrate the surface.

For most cases only a damp cloth is sufficient for cleaning.

Regular cleaning highlights the aesthetic features of the surface and gives it exceptional shine.

For highly aggressive cleaning caused by some common food and substances follow the table below.

Type Of stain	Chemical Product	Example
Grease	Alkaline - Solvent	Detergent
Oil	Solvent	Ammonia, Baking Soda
Ink	Oxidant - Solvent	Alcohol, Liquid Bleach, Nail Paint Remover
Rust	Acid	Hydrochloric Acid, Vinegar, Red Harpic
Lime	Acid	Descaling Reagent, Hydro Chloric Acid
Cement	Acid	Hydro Chloric Acid
Wine	Alkaline	Ammonia, Liquid Bleach
Coffee	Alkaline - Solvent	Ammonia, Liquid Bleach
Rubber	Solvent	Alcohol, Thinner
Plaster	Acid	Hydro Chloric Acid
Candle Wax	Solvent	Alcohol, Thinner
Iodine	Oxidant	Liquid Bleach
Blood	Oxidant	Liquid Bleach
Ice Cream	Alkaline	Liquid Bleach

Note: It is recommended that any kind of stain needs to get clean immediately / as soon as possible.

TECHNICAL SPECIFICATIONS

CHARACTERISTICS	STANDARD AS PER ISO-13006/2018 En14411 gr.bla	ROCK VALUE	TEST METHOD
Regulatory Properties			
Deviation in Length & Width	± 0.5%	± 0.2%	ISO 10545-2
Deviation in Thickness	± 5%	± 5%	ISO 10545-2
Straightness of Sides	± 0.5%	± 0.2%	ISO 10545-2
Rectangularity	± 0.5%	± 0.2%	ISO 10545-2
Surface Flatness	± 0.5%	± 0.3%	ISO 10545-2
Colour Difference	ΔE<1.00	ΔE<0.30	ISO 10545-16
Glossiness	As per Mfg.	As Per Mfg.	Gloss Meter
Regulatory Properties			
Water Absorption	≤ 0.5 %	≤ 0.03 %	ISO 10545-3
Apparent Density	As per Mfg.	>2.20 g/cc	ISO 10545-3
Massive Mechanical Properties			
Modulus of Rupture	Min.35N/mm ²	Min.40N/mm ²	ISO 10545-4
Breaking Strength	Min.1300 N	Min. 7000 N	ISO 10545-4
Impact Resistance	As per Mfg.	Min. 0.55	ISO 10545-4
Surface Mechanical Properties			
Surface Abrasion Resistance	As per Mfg.	Min. class 3	ISO 10545-7
Mohs Hardness	As per Mfg.	Min. class 4	BS EN 15771
Massive Mechanical Properties			
Frost Resistance	As per Mfg.	Frost Proof	ISO 10545-12
Thermal Shock Resistance	Min. 10 Cycle	Min. 10 Cycle	ISO 10545-9
Moisture Expansion	Max. 0.6mm/m	Max. 0.2mm/m	ISO 10545-10
Thermal Expansion	Max. 9.0 x 10 ⁻⁶	Max. 6.0x10 ⁻⁶	ISO 10545-8
Chemical Properties			
Chemical Resistance	As per Mfg.	No Damage	ISO 10545-13
Stain Resistance	Resistant	Resistant	ISO 10545-14
Safety Properties			
Slip Resistance	As per Mfg.	N.A.	DIN 51130
Fire Resistance	As per Mfg.	Fire Proof	N.A.

PACKING DETAILS

Dimension (mm)	No. of Pcs/Box	Square Feet	Weight (Approx)
800x3200mm	1 Pcs.	27.55 Sq. ft	90 kg.
800x3000mm	1 Pcs.	25.83 Sq. ft	83 kg.
800x2400mm	1 Pcs.	20.67 Sq. ft	68 kg.

ROCK

ROCK SLABS LLP

Near Rock Granito Llp, Uchi Mandal,
Morbi (Gujarat) - 363642

www.rockgranito.com • info@rockgranito.com